



TRAINING MANUAL

Global Tech China Ltd, 3 Floor, Wai Yip Industrial Building, 171 Wai Yip Street,
Kwun Tong, Kowloon, Hong Kong.

Tel: +852 2884 4318 Fax: +8522884 4816

www.sunsynk.com / sales@globaltech-china.com / www.globaltechhk.com

INDEX

1. INTRODUCTION	7
1.1. WHAT IS A HYBRID INVERTER	7
1.2. A SIMPLE HYBRID INVERTER	8
1.3. TYPES OF HYBRID INVERTERS	8
1.3.1. BASIC HIGH-FREQUENCY CHANGEOVER INVERTERS	9
1.3.2. BASIC HIGH-FREQUENCY CHARGER INVERTERS	9
1.3.3. MULTI-MODE HYBRID INVERTERS	9
1.3.4. AC COUPLED HYBRID INVERTERS	9
1.3.5. BI-DIRECTIONAL DRIVER HYBRID INVERTERS	10
2. SUNSYNK PARITY BI-DIRECTIONAL DRIVER TYPE HYBRID INVERTER	11
2.1. THE HEART OF SUNSYNK IS A 8.8KW BI-DIRECTIONAL INVERTER	11
2.2. THE INVERTER CAN SWITCH CIRCUITS IN AND OUT BY CONTROLLING RELAYS.....	13
2.3. UNDERSTANDING HOW THE INVERTER OPERATES IS ESSENTIAL WHEN SELECTING THE CORRECT WIRING CONFIGURATIONS.....	13
2.3.1. SYSTEM FLOW.....	14
3. INSTALLING THE SUNSYNK INVERTER	17
3.1. MOUNTING THE INVERTER	17
3.2. BATTERY CONNECTION	19
3.2.1. BMS.....	21

3.3. AC GRID CONNECTION	24
3.3. INSTALLING THE CT COIL.....	25
<u>4. MAXIMUM POWER POINT TRACKERS (MPPTS).....</u>	<u>29</u>
<u>5. THE DISPLAY.....</u>	<u>32</u>
5.1. HOME SCREEN	33
5.2. STATUS PAGE	34
5.2. STATUS PAGE	35
5.2. SET UP / PROGRAMMING PAGE	36
<u>6. OPERATION MODES</u>	<u>37</u>
6.1. ON-GRID WITH NO PV	38
6.2. ON-GRID WITH UPS.....	40
6.3. USING A GENERATOR – WIRING / COMMON ISSUES / PROGRAMMING	41
6.4. EARTH CONNECTION (MANDATORY)	45
6.4.1. EARTH BOND RELAY	46
6.5. AUXILIARY / SMART LOAD.....	48
6.6. PEAK SHAVING	49
6.7. WIND TURBINES	51
<u>7. PARALLELING INVERTERS.....</u>	<u>53</u>
7.1. SINGLE-PHASE CONFIGURATION	56
7.2. THREE-PHASE CONFIGURATION	57

LIST OF FIGURES

FIGURE 1 - SUNSYNK SUPER HYBRID PARITY INVERTERS.	7
FIGURE 2 - SIMPLE REPRESENTATION OF A HYBRID INVERTER.	8
FIGURE 3 - SUNSYNK PARITY INVERTER DIAGRAM.	11
FIGURE 4 - BOTTOM VIEW OF THE 3.6kW/5.5kW MODEL.....	12
FIGURE 5 - BOTTOM VIEW OF THE 8.8kW MODEL.....	12
FIGURE 6 - 3.6kW/5.5kW MODEL (SMALL SIZE INVERTER)	12
FIGURE 7 - 8.8kW MODEL (LARGE SIZE INVERTER)	12
FIGURE 8 - CIRCUIT BLOCK DIAGRAM.	13
FIGURE 9 - FLOW WITH COMBINED MPPTS.	14
FIGURE 10 - PRIORITISE LOAD OR BATTERIES.	15
FIGURE 11 - UPS TAKE MODE EXAMPLE.	16
FIGURE 12 – KEITH GOUGH AT A SUNSYNK INSTALLATION IN PORT ELIZABETH.....	17
FIGURE 13 - DISTANCE BETWEEN INVERTERS.	18
FIGURE 14 - SUNSYNK INVERTER INSTALLATION - BLACK VERSION.	18
FIGURE 15 – RECOMMENDED DC SURGE PROTECTOR FOR THE BATTERIES.....	20
FIGURE 16 - INVERTERS WITH APPROPRIATE BATTERY CONNECTIONS.....	20
FIGURE 17 - CAN/RS485 AND RS232 CONNECTIONS.	22
FIGURE 18 - DISPLAYED INFORMATION FROM THE LI BMS.....	23
FIGURE 19 - COMPLETE SYSTEM WITH PROTECTION DEVICES.	25
FIGURE 20 - 16MM APERTURE SPLIT CORE CURRENT TRANSFORMER.	26
FIGURE 21 - WIRING SCHEMATIC DIAGRAM.	26
FIGURE 22 - CT COIL CONNECTION.....	27
FIGURE 23 - CT COIL CONNECTIONS.	27
FIGURE 24 - CT COIL CONNECTIONS IN THE INVERTER.	28
FIGURE 25 - STATUS PAGE AND THE CT COIL POWER.	28

FIGURE 26 - STRINGS.	29
FIGURE 27 - PV CONNECTIONS OF THE 8.8 kW INVERTER.	31
FIGURE 28 - 3.6kW/5.5kW BOTTOM VIEW.....	31
FIGURE 29 – AMAZING INTERFACE OF THE SUNSYNK INVERTER.	32
FIGURE 30 - HOME SCREEN.	33
FIGURE 31 - STATUS PAGE.....	34
FIGURE 32 - INTERFACE WITH THE FLOW CHART.....	35
FIGURE 33 – SET UP / PROGRAMMING PAGE.	36
FIGURE 34 - SYSTEM MODE PAGE.	37
FIGURE 35 – ON-GRID WITH NO PV EXAMPLE.....	39
FIGURE 36 - ON-GRID WITH UPS EXAMPLE.	41
FIGURE 37 - BATTERY SETUP PAGE.....	42
FIGURE 38 - AUX LOAD PAGE.....	43
FIGURE 39 - EXAMPLE OF TWO WORKING INVERTERS AND A CHARGER INVERTER.	44
FIGURE 40 - GROUND CONNECTION.	45
FIGURE 41 - EARTH BOND.	47
FIGURE 42 - SIGNAL ISLAND MODE.....	47
FIGURE 43 - AUX LOAD IN USE.....	48
FIGURE 44 - AUX LOAD DIAGRAM.	48
FIGURE 45 - PEAK SHAVING.	49
FIGURE 46 - PEAK SHAVING SETTING.	50
FIGURE 47 - WIND TURBINE COMBINER BOX.	51
FIGURE 48 - WIND TURBINE WITH SELF-BREAKING.	52
FIGURE 49 - DUMP LOAD.	52
FIGURE 50 - WIND TURBINE CONFIGURATION.	52
FIGURE 51 - INSTALLATION WITH MANY INVERTERS.	53
FIGURE 52 - PARALLELING INVERTERS PAGE.	53
FIGURE 53 – PARALLELING INVERTERS.	54

FIGURE 54 - DIP SWITCH.....	55
FIGURE 55 - SUNSYNK INVERTERS PARALLELED.	56
FIGURE 56 - SIX INVERTERS PARALLELED.....	57
FIGURE 57 - FAULT CODE PAGES.....	58
FIGURE 58 - GRID SETUP PAGE.....	61
FIGURE 59 - INVERTER INSTALLED IN A DUSTY ENVIRONMENT.....	63

LIST OF TABLES

TABLE 1 - BATTERY GUIDE.....	19
TABLE 2 - CAN/RS485 AND RS232 PINS DESCRIPTION.....	22
TABLE 3 - RCD.....	46

1. INTRODUCTION

This training manual has been specifically designed around a Sunsynk Super Hybrid Parity Inverter. It has been written to give you a clear understanding of how to install the inverter, but please refer to the inverter handbooks for detailed programming.



Figure 1 - Sunsynk Super Hybrid Parity Inverters.

1.1. WHAT IS A HYBRID INVERTER

The word hybrid means a mixture of two different things or technologies. But, in the field of electrical engineering, a hybrid inverter characterizes an inverter that can connect to several power sources such as alternate current (AC), battery, and solar. In other words, it may have many different variants. However, the term 'solar hybrid inverter' usually refers to an inverter that connects to AC power, solar PV panels, and batteries.

The batteries can be charged both from the AC and solar power, and the inverter can supply the AC output. *With this technology, the customer can store energy at night, by charging the batteries from the AC when the energy price of the utility grid is low, and during the daytime, the batteries can give power out. By doing this, a lot of money can be saved annually.*

1.2. A SIMPLE HYBRID INVERTER

A simple way to represent a hybrid inverter is actually by an off-grid inverter with a changeover contactor (a large relay). Many so-called hybrid inverters are standard off-grid inverters with a charger circuit and a changeover switch, as presented in the diagram of Figure 2.

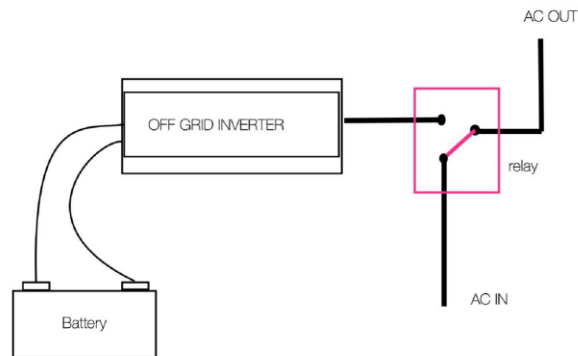


Figure 2 - Simple representation of a hybrid inverter.

The diagram presented in Figure 2 will give you a basic system. However, it has many flaws. The biggest issue with this system in [residential applications](#) is that the total power of the house must be powered through the inverter. Therefore, if you have a peak demand of 20kW in your house, then you must get a huge 20kW inverter or bigger to allow for peaks.

Also, in this type of inverters, the AC charge circuits (If any) tend to be quite small. Therefore, charging from the AC will take a long time.

1.3. TYPES OF HYBRID INVERTERS

First of all, inverters can be divided into two categories: low frequency and high-frequency inverters. These apply to a hybrid, string, and battery inverter that can all be low-frequency or high-frequency inverters.

High-frequency inverters fall into two categories as well, (Metal-Oxide-Semiconductor Field Effect Transistor) MOSFET driven inverters and Insulated-Gate Bipolar Transistors (IGBTs) driven inverters. Inverters that employ MOSFET technology are traditional high-frequency inverters, and this drive technology is used in the more professional inverters. [Currently, some inverters use Silicon-Carbide MOSFETs \(SiC MOSFETS\) that present some advantages such as higher current and voltage breakdown, heat transfer, and efficiency. But this new technology is expensive and still have some problems.](#) On the other hand, inverters

generally use IGBTs, which are more feasible and have the main advantage of being much stronger than MOSFETs when susceptible to surges and back EMF.

1.3.1. BASIC HIGH-FREQUENCY CHANGEOVER INVERTERS

A high-frequency inverter with a changeover switch is merely a standard off-grid inverter. This is the type of inverter that you will buy in a car shop or take to camping. It has a relay or a contact in the front end to allow the AC to pass directly from the grid to the load. When the grid fails, the relay can change over and divert the power from the load to the inverter.

1.3.2. BASIC HIGH-FREQUENCY CHARGER INVERTERS

This inverter is similar to the above except that it has an additional small battery charger. Therefore, it is possible to charge the batteries through the AC grid for later use.

1.3.3. MULTI-MODE HYBRID INVERTERS

Multi-mode hybrid inverters tend to be a larger version of the charger inverter, usually 5kW or 8kW. This inverter has a few more features than a charger inverter, and some can even be wired in parallel.

Many of these inverters of this type will have communication software to work with lithium batteries (BMS).

1.3.4. AC COUPLED HYBRID INVERTERS

The great advantage of an AC coupled hybrid inverter is that it operates similarly to an on-grid inverter. Therefore, you can have a much smaller inverter and do not need to worry about the peak demand of the load since it is connected directly to the AC.

Some of these inverters have an uninterruptible power supply (UPS) feature. [The loads connected to this output will operate even if a power failure happens. Therefore, you can connect essential loads, such as lights, that will operate even during a power failure.](#) Also, some AC coupled hybrid inverters can be wired in parallel.

1.3.5. BI-DIRECTIONAL DRIVER HYBRID INVERTERS

These are often referred to as 'super inverters'. The main advantage of this type is that the inverter can reverse and charge the batteries with very high power when required. They are fantastic for use as UPS, there is no limitation on the size of inverter versus the load, and these inverters use IGBT, which makes them much more reliable against surges and back EMF.

2. SUNSYNK PARITY BI-DIRECTIONAL DRIVER TYPE HYBRID INVERTER

2.1. THE HEART OF SUNSYNK IS A 8.8KW BI-DIRECTIONAL INVERTER

The Sunsynk Parity Inverter is a bi-directional driver type hybrid inverter. The mains connector on the inverter is an input and an output [since it is bidirectional](#).

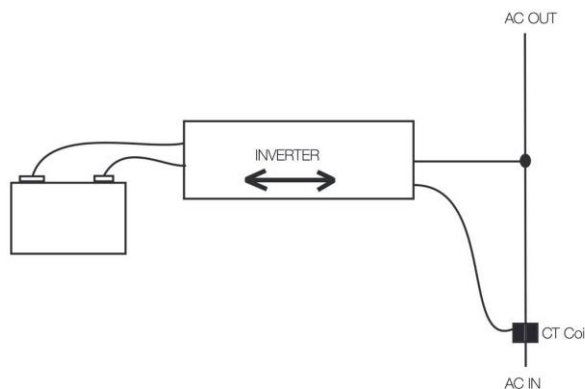


Figure 3 - Sunsynk Parity Inverter diagram.

IMPORTANT:

When using our inverter without batteries, you can only connect to the grid connection, which is both an input and output, similar to a standard string inverter.

Many customers misunderstand the use of the inverter and connect the outputs to the 'LOAD' and the input to the 'GRID' connection when there are no batteries. This is simply wrong, and the inverter will not function correctly.

In Figure 4 and Figure 5, you can see a 'GRID' input and a 'LOAD' input. Do not think that the 'GRID' is the input and the 'LOAD' connection is the output. **The 'GRID' is an input and an output, and the 'LOAD' is a UPS.**

Therefore, **when you have batteries**, you will connect only essential loads such as lights, security devices, routers, and computers to the 'LOAD' connection and, in the 'GRID' connection, you will connect the non-essential loads such as most sockets, air conditioning, heaters, etc.

However, **if you do not have batteries**, you **will not** use the 'LOAD' connection. You must connect all your loads to the GRID input.



Figure 4 - Bottom view of the 3.6kW/5.5kW model



Figure 5 - Bottom view of the 8.8kW model



Figure 6 - 3.6kW/5.5kW model (small size inverter)



Figure 7 - 8.8kW model (large size inverter)

2.2. THE INVERTER CAN SWITCH CIRCUITS IN AND OUT BY CONTROLLING RELAYS

In addition to the grid connection of the Sunsynk inverter, the LOAD connection and a GEN/AUX connection are basically all the same, but they are switched in and out via a number of relays.

IMPORTANT:

Note the inverter can only do one thing momentarily, you can either charge the batteries using the inverter or discharge the batteries using the inverter. If you are charging the batteries, you must be connected to a generator or an AC load to have a source of power to charge the batteries. This works separately from the MPPT, which will also charge the batteries if the MPPT/solar supplies power to the inverter.

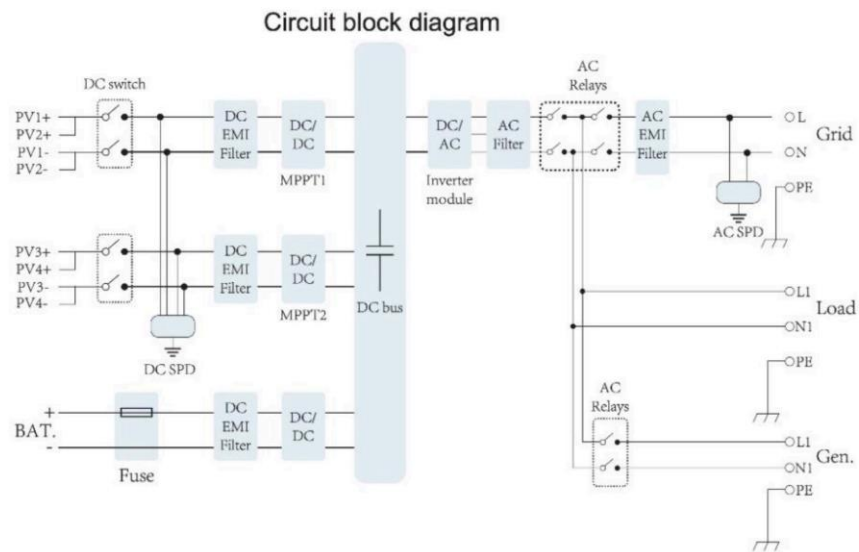


Figure 8 - Circuit block diagram.

2.3. UNDERSTANDING HOW THE INVERTER OPERATES IS ESSENTIAL WHEN SELECTING THE CORRECT WIRING CONFIGURATIONS

If you press the bar chart on the inverter's display, it will come up with a screen showing the flow of what the inverter is doing. This is very useful and very unique to the Sunsynk inverter.

The most important thing about a hybrid inverter is the battery and its ability to store/provide power when needed.

2.3.1. SYSTEM FLOW

The flow can start either from just the mains or from the solar. For the sake of this illustration, we will start the flow from the solar power.

1. If the inverter has two MPPTs and they are combined to make one power source:

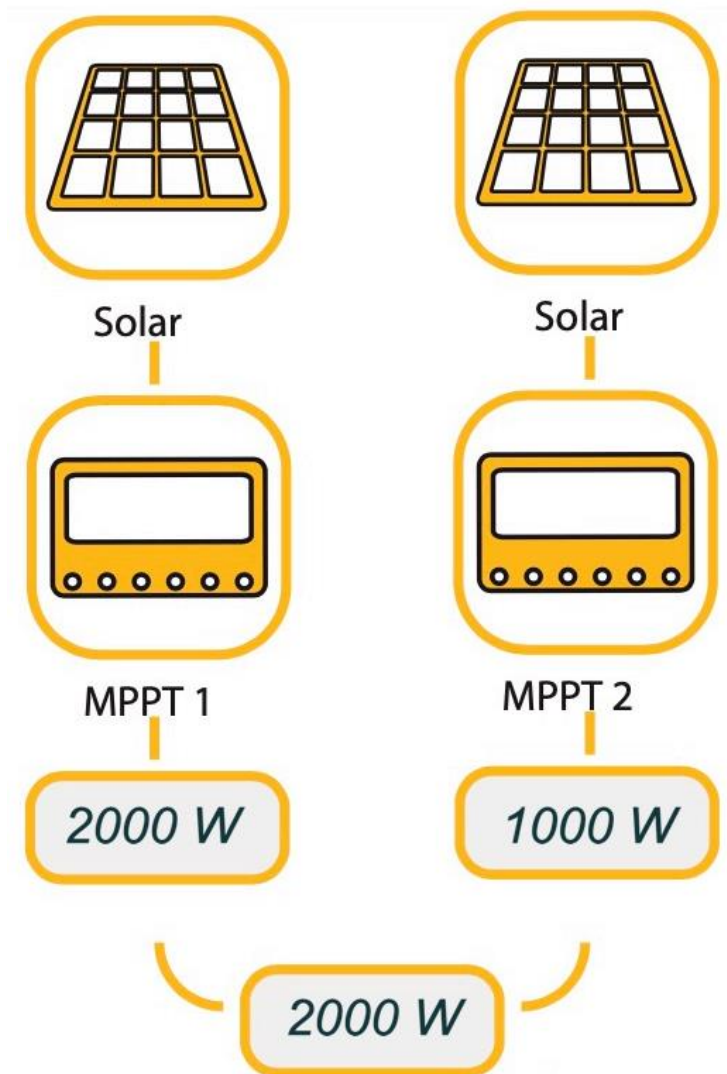


Figure 9 - Flow with combined MPPTs.

2. The output of the MPPTs can be prioritised either to charge the battery or to supply the load. This is a selectable option:

This is selected via the controller, tick priority to load to divert the solar power to the load; any surplus will charge the battery. If you untick, it will prioritise to charge the battery first and any surplus will power the load.

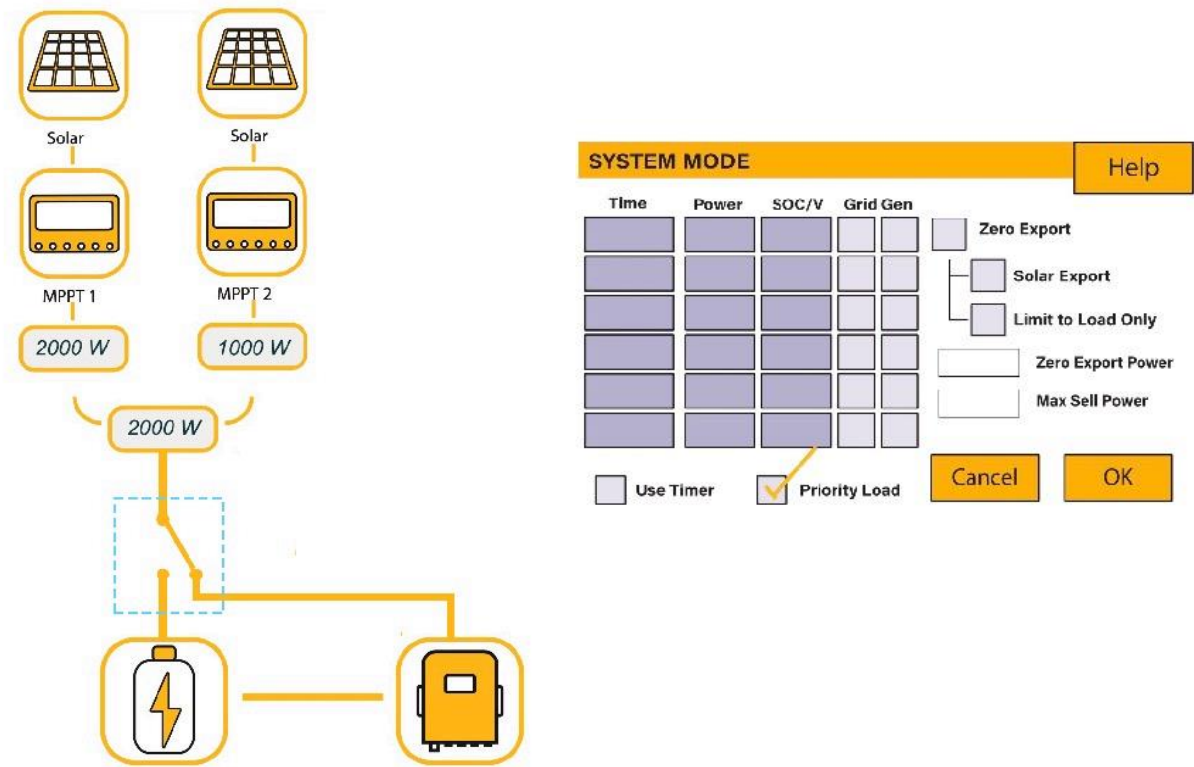


Figure 10 - Prioritise load or batteries.

IMPORTANT:

We often get many installers contacting us, saying that the sun is shining, yet the inverter is still using grid power. This is probably because the solar has been diverted to charge the batteries first. Therefore, it will initially charge the batteries only, and then when the batteries are fully charged it will start using the solar power to power the load.

3. The inverter is then connected to the grid, load, and auxiliary:

The example shown in Figure 11 is showing the inverter running in a UPS take mode. The inverter is drawing power from the grid to charge the batteries and also supply the load. In the case of a power failure, then the inverter will reverse and supply the load.

These outputs 'AUX', 'LOAD' (UPS), and 'GRID' are all controlled via a number of relays. Depending on the control, the setting will depend on what the inverter will do with the power. If you can understand this part of the inverter, you will totally understand how it works.

When connecting to the grid, we also use a CT coil, and I will discuss the use of a CT coil further in this manual.

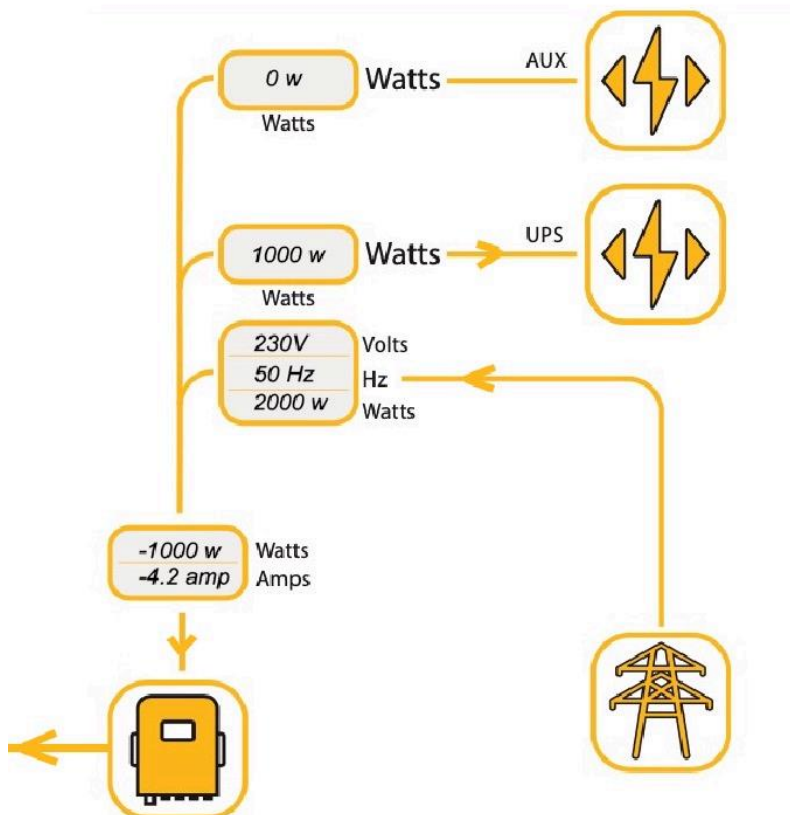


Figure 11 - UPS take mode example.

3. INSTALLING THE SUNSYNK INVERTER

3.1. MOUNTING THE INVERTER

If you are now familiar with the inverter and how it functions and is a licensed electrical engineer, you are ready to install one of our amazing machines.

Be careful on choosing the location to mount the inverter. Please refer to the user manual for the best mounting position/location.



Figure 12 – Keith Gough at a Sunsynk installation in Port Elizabeth.

IMPORTANT:

- Do not fit the inverter in any area where it is going to be too hot if the environmental temperature is too hot or very high humidity. These conditions can cause the inverter to overheat, so additional air conditioning or ventilation may be required.
- Ensure that the inverters are mounted securely on the wall.
- When using multi-inverters, try to keep them a metre apart, because if they get very close to each other, it may obscure the cooling system of the inverter.
- For more information, refer to the user manual.

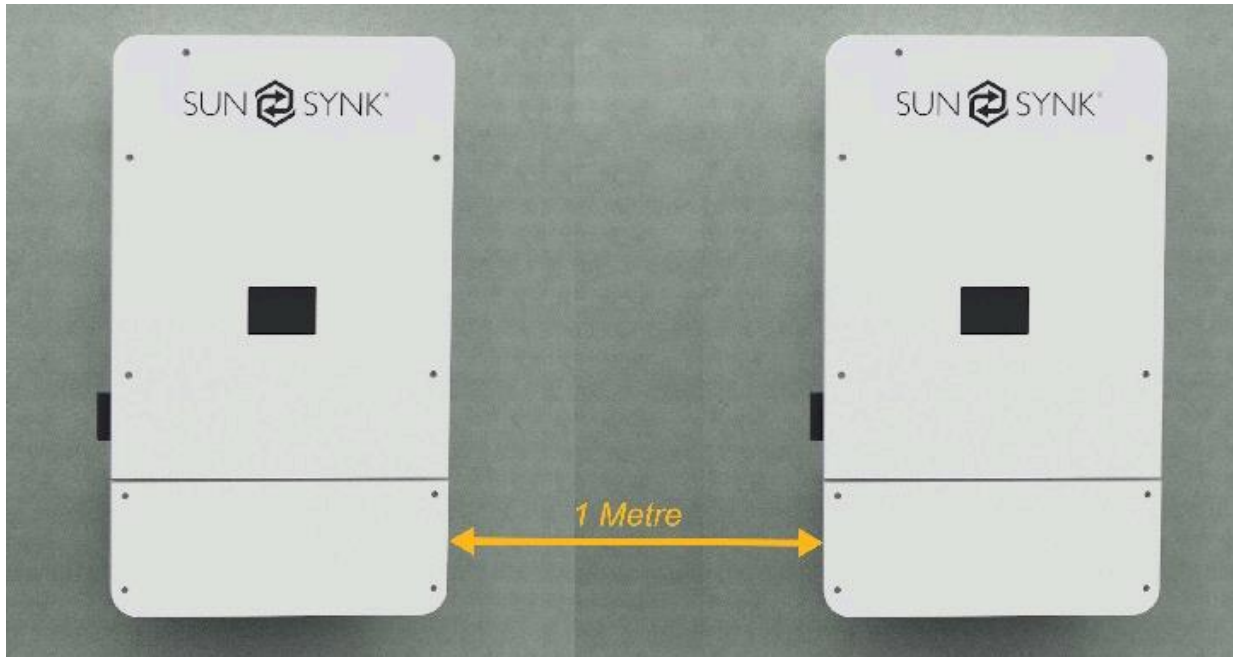


Figure 13 - Distance between inverters.

When connecting the inverter, it is not only good practice but maybe also a mandatory requirement to run the AC and the DC cables in separate trunking.



Figure 14 - Sunsynk inverter installation - black version.

3.2. BATTERY CONNECTION

The Sunsynk machine can work with both lithium and AGM batteries. The type of battery you choose would often depend upon your budget.

An important thing to be aware of with your battery is the C rating. This is the maximum charge and discharge of the battery. Charging or discharging the batteries with too much current can be dangerous and also damage the battery cells. Once the Sunsynk inverter can deliver a high current level, be careful when selecting the batteries and setting the parameters.

The batteries are often rated higher, but my advice is to keep it well below the C rating of the battery. Generally, AGM batteries have a safe C rating of 0.1, and lithium batteries have a safe separating of 0.35.

Remember: 4x12V AGM in series will give you just the same C rating.

Below is a rough guide only. For more accurate information, you need to refer to the battery manufacturers specifications.

Table 1 - Battery guide.

	4 x 200 AH AGM	8 x 200 AH AGM	1 x 5KW Lithium	4 x 5KW Lithium
Max Charge Current	20 Amp	40 Amp	35 Amp	140 Amp
Max Discharge Current	20 Amp	40 Amp	35 Amp	140 Amp
Cable Size	35 mm	35mm	35mm	50 mm
Fuse Rating	40 Amp	80 Amp	70 Amp	240 Amp

Take great care when connecting batteries, as they can be very dangerous.

For safe operation and compliance, an individual DC overcurrent protector or disconnection device is required to connect the battery and the inverter. It is recommended to utilise a suitable fuse and DC isolator (check Figure 15).

Recommended DC Surge Protector:

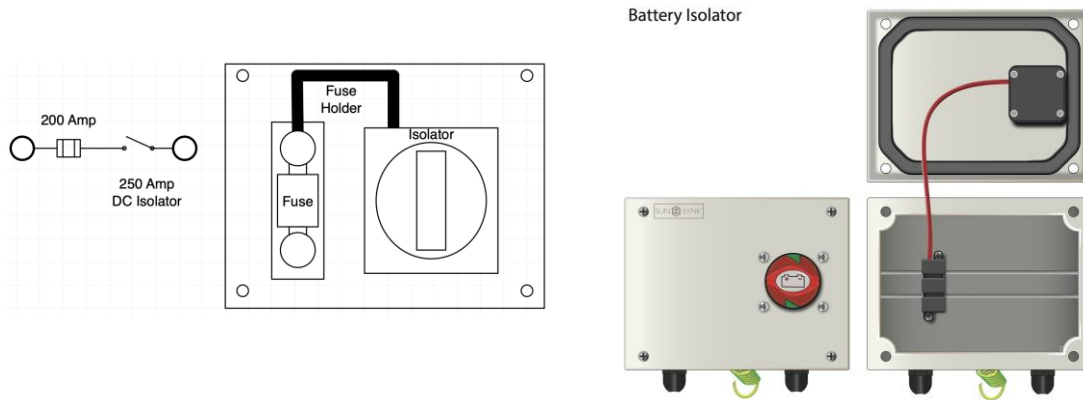


Figure 15 – Recommended DC surge protector for the batteries.

In some applications, switching devices may not be required, but overcurrent protectors are still required.

IMPORTANT:

Observe the polarity of the battery terminals on the inverter. If you wire the battery terminals the wrong way around, you will destroy the inverter and invalidate your warranty.

Before making the final DC connection or closing the DC breaker/ disconnection device, ensure that the inverter is wired properly. Reverse polarity connection on the battery will damage the inverter.



Figure 16 - Inverters with appropriate battery connections.

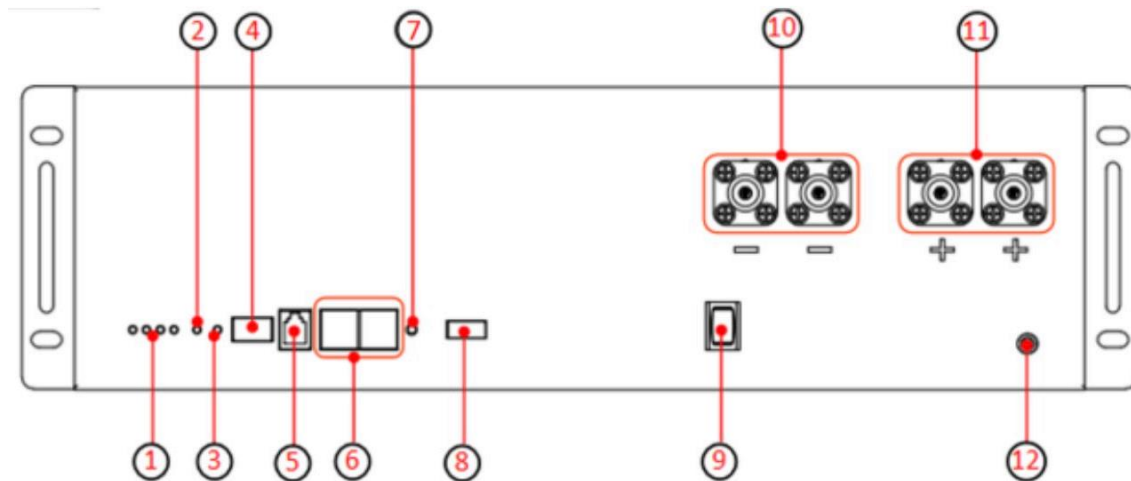
3.2.1. BMS

Most lithium batteries have a BMS battery management system.

Without the use of a BMS, it is very difficult for the inverter to know the State of Charge (SOC). Therefore, the BMS will provide the inverter with the SOC and the maximum charge and discharge parameters that are allowed for that particular battery.

When connecting a lithium battery, you must hook up a communication cable between the inverter and the battery. Every battery has different settings, so you need to refer to the manufacturer user manual and also check on our user manual to see if that particular battery can be used

The battery may look like this:



Item	Name	Model	Remarks
1	SOC LED x4		
2	Alarm LED		
3	RUN LED		
4	Dialer		
5	Communication port	RJ11	RS232 To upper machine
6	Communication port *2	RJ45	CAN To PCS RS485 Internal Connection
7	Reset		Waken system from malfunction status
8	Dry Contact		
9	Power On/Off Switch		
10	Port Negative x2	PSR6XAB	Black 5.7, 25mm ²
11	Port Positive x2	PSR6XBB	Orange 5.7, 25mm ²
12	GND	M6	Yellow-Green, 10AWG

Depending upon the type of battery you are using, it may require either car or RS232 communication. The Sunsynk inverter supports both methods of communication.

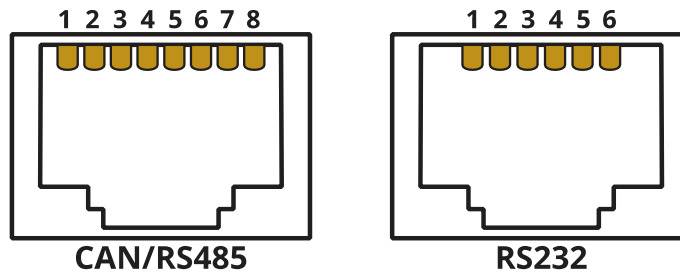


Figure 17 - CAN/RS485 and RS232 connections.

Table 2 - CAN/RS485 and RS232 pins description.

	Description
CAN	Pin 4: CAN-H Pin 5: CAN-L Pin 1, 3, 6, 7, 8: NC
RS485	Pin 1: RS485B Pin 2: RS485A Pin 3: GND Pin 6: GND Pin 7: RS485B Pin 8: RS485A Pin 4, 5: NC
RS232	Pin 3: BMS transmit; Computer receiver Pin 4: BMS receiver; Computer transmit Pin 5: GND Pin 1, 2, 6: NC

IMPORTANT:

The battery communication is separate from the parallel communication ports. Do not mix them up!

For the inverter and battery settings, please refer to our inverter handbook or the battery manufacturer.

After installing a lithium battery, check on the communications page by clicking on 'Li BMS' icon to see if the BMS information is visible. If some information is not displayed correctly on the page as shown in the figures below, there is a communication error.

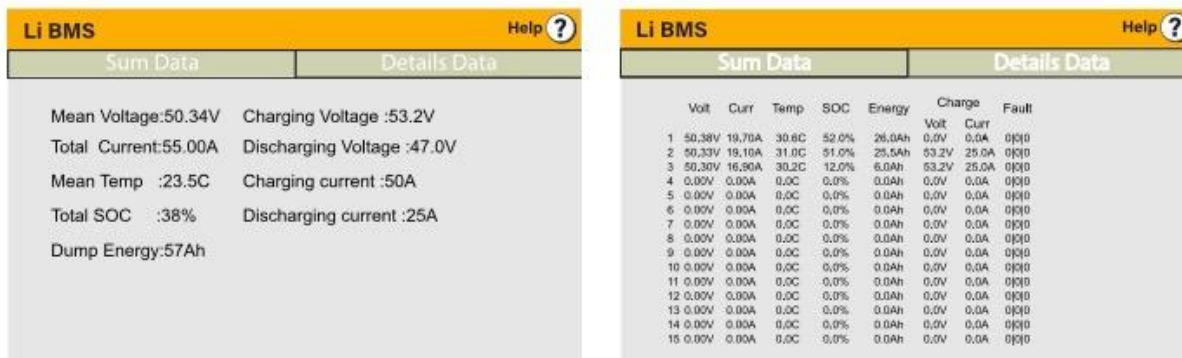


Figure 18 - Displayed information from the Li BMS.

Therefore, if a communication error shows up on display:

- 1) Check if your data cable is the correct type.
- 2) Check if you are plugging the cable into the correct sockets.

Usually, RS 485 is employed, but some battery manufacturers use others.

In some types of lithium batteries, the BMS cannot be controlled by Sunsynk inverter. In this case, treat the battery as a lead-acid type and set the charging and discharging protocol following the battery manufacturer specification.

IMPORTANT:

When not using communications between battery and inverter, never overcharge your battery bank concerning current and voltage. Many lithium batteries are limited to 100A, some are lower, and some are higher. Therefore, ensure that voltage and current specifications provided by the battery manufacturer are followed.

If you are using lead-acid batteries, then a good rule of thumb is $C \times 0.1$, which means that the maximum charge or discharge you can apply to the battery is 10% of the Ah rating of the overall battery array. For example, a 200Ah battery array composed of 4 x 200 power batteries in series has a maximum charge and discharge of 20A. Then, you can check Table 1 to select the cable size and fuse rating. But, remember to follow the recommendations of the battery manufacturers to ensure that the cable is thick enough to support the current and a proper fuse is used.

3.3. AC GRID CONNECTION

The inverter connection to mains depends a lot on the installation type. But, usually, the mains should always be connected to the grid connection via any suitable protection device, of course.

IMPORTANT:

If using the inverter without batteries, only use the grid connection. Do not connect anything to the 'AUX/GEN' connection because this will cause problems.

If you connect the inverter to a system with no grid available, all essential and nonessential loads will be connected via the 'LOAD' output, therefore, the inverter will operate in island mode. In this situation, you can connect a generator onto the grid side. This can be used to charge the batteries and supply the load when the batteries have a low charge and there is not enough sunshine to the PV supply loads and charge the batteries.

The auxiliary input 'GEN/AUX' can be used to connect a generator. Please refer to the section using generators.

IMPORTANT:

When using inverters in parallel mode, the generator port cannot be used. The reason for this is because the inverter reverses when charging the batteries.

If you have more than one inverter connected together, then it causes a huge problem when one inverter reverses and the others do not. Therefore, if using multi inverters that can reverse in parallel, you must use the grid input to charge the batteries from the generator.

When wiring your AC connections, you need to provide suitable changeover switches and correct rating fuses. Please refer to the local electrical regulations.

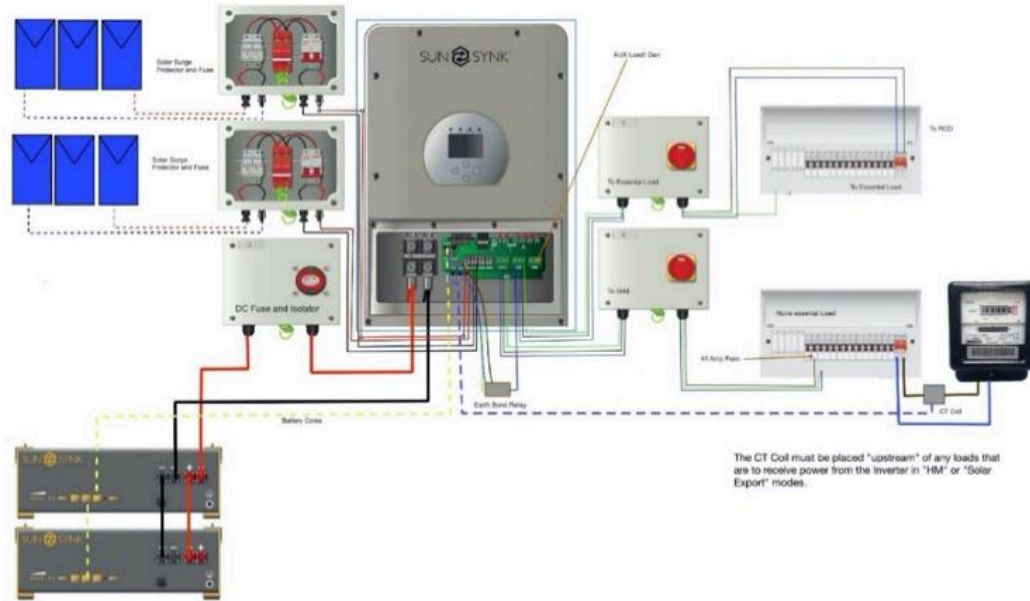


Figure 19 - Complete system with protection devices.

3.4. INSTALLING THE CT COIL

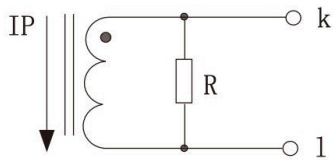
A 1:2000 current transformer (CT) is used to control the power export or the import from the grid. The CT coil is one of the most important parts of the Sunsynk Parity inverter. This device reduces the power of the inverter to prevent feeding power to the grid. This feature is also known as "Zero Export".

An example is presented in Figure 20 and Figure 21 shows the wiring schematic diagram.

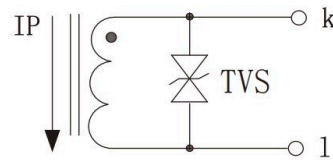


Figure 20 - 16mm aperture split core current transformer.

Wiring schematic diagram:



Built-in sampling resistance
Voltage output type
Secondary doesn't allow short circuit



TVS: Transient voltage suppressor
Current output type
Secondary doesn't allow open circuit

Figure 21 - Wiring schematic diagram.

IMPORTANT:

You need to be careful when using the CT. Please ensure that it is wired correctly.

If you want to export, you can, but the benefit of the CT Coil is that the power generated during the day can be consumed by the house appliances and/or, instead of being exported, it can be stored into the batteries for later use.

- 1) Fit the coil (sensor) around the live cable on the main fuse feeding the building and run the cable back to the inverter. This cable can be extended up to an extra 10m using a similar cable.
- 2) Connect the other end of the CT coil into the inverter terminals marked as CT coil. It basically allows the great connection to work as a one-way street.

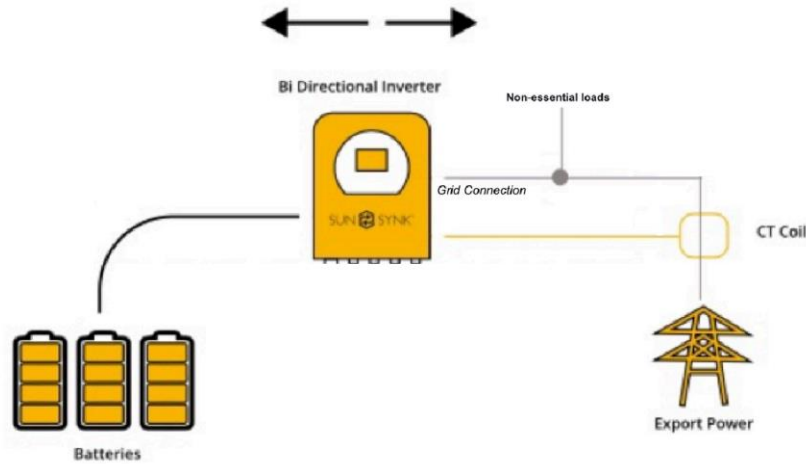


Figure 22 - CT coil connection.

Ideally, you do not want to run the CT coil any further than 10m away from the inverter. But, it will work up to 20m if you do not have any external interference if you do extend the cable on the CT coil. Please ensure using the same type of twisted cable.

On the back of the CT coil, there are markings L and K. The current runs from K to L. There is a small arrow on the CT coil showing you the direction of flow.

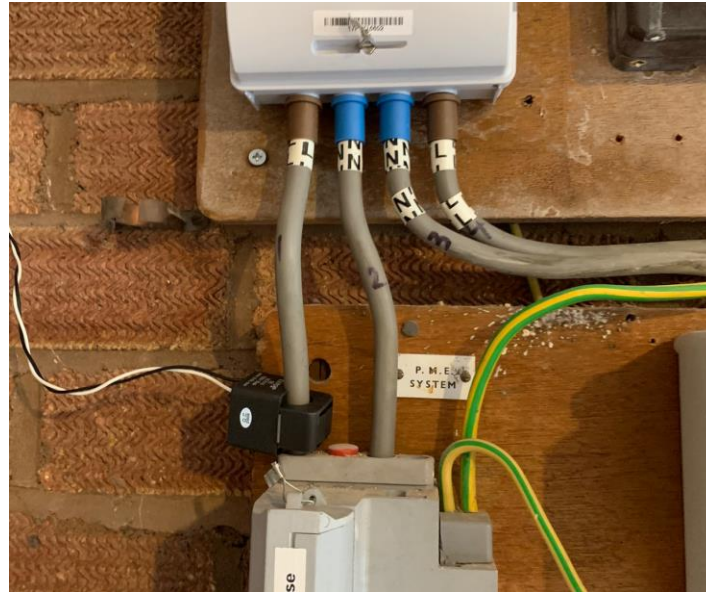


Figure 23 - CT coil connections.

It is important that the grid is connected to follow the arrow into the inverter. The CT coil has two coloured cables: white and black. The white cable is the positive and the black is negative. Please ensure that they

are connected correctly to the inverter. If they are connected backward, a negative value will be shown on the screen, as presented in .

Before connecting to the inverter, please refer to the user manual.

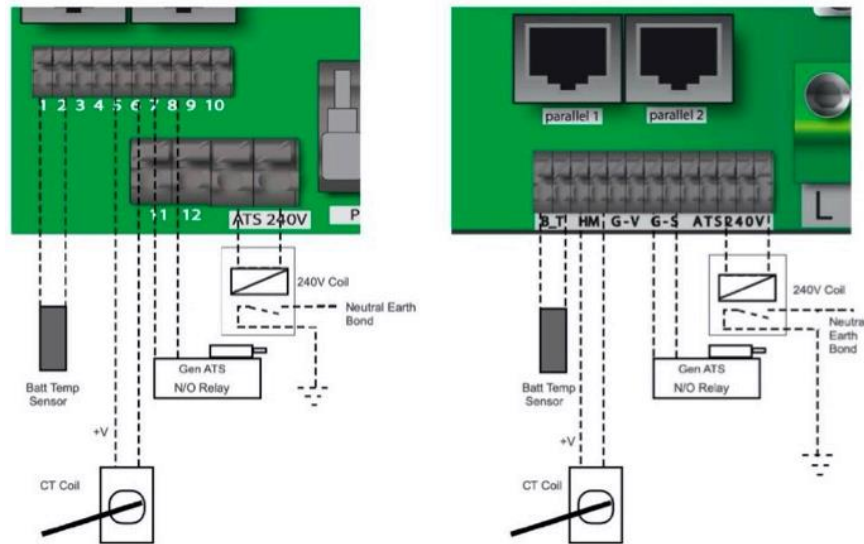


Figure 24 - CT coil connections in the inverter.

0 Watts 0.00 V 0.00 Amps 0.0 C	0 watts 0 Hz 0 Volts 0.0 Amps CT:0Watts LD: 0Watts	0 Watts 0.00 Volts 0.0 Amps
Battery	Grid Power	Solar Power 1
0 watts 0 Hz 0 Volts 0.0 Amps DC:100.0 C AC:100.0 C	0 Watts 0.00 Volts 0.0 Amps	0 Watts 0.00 Volts 0.0 Amps
Inverter Power	Load Power	Solar Power 2

IMPORTANT

If the CT coil is fitted in the wrong way then this variable will have negative instead of positive values when the power is flowing into the house/inverter. Also, the inverter export limiting function will not work properly.

Figure 25 - Status page and the CT coil power.

4. MAXIMUM POWER POINT TRACKERS (MPPTS)

The main reason for using MPPTs chargers rather than PWM is because it is much more efficient. For example: if you are going to charge a 12V battery with a 100W 25V solar panel, it will charge at 4A. Now, multiply 12V by 4. It results in only 48W, and the other 50W are gone!!!

Another major advantage of and MPPT is allowing the solar panels to run higher voltages, which reduces losses on cables.

Depending on the type of inverter you are using, it may allow one or two strings per MPPT. The larger inverters, 8kW and above, normally have two strings per MPPT.

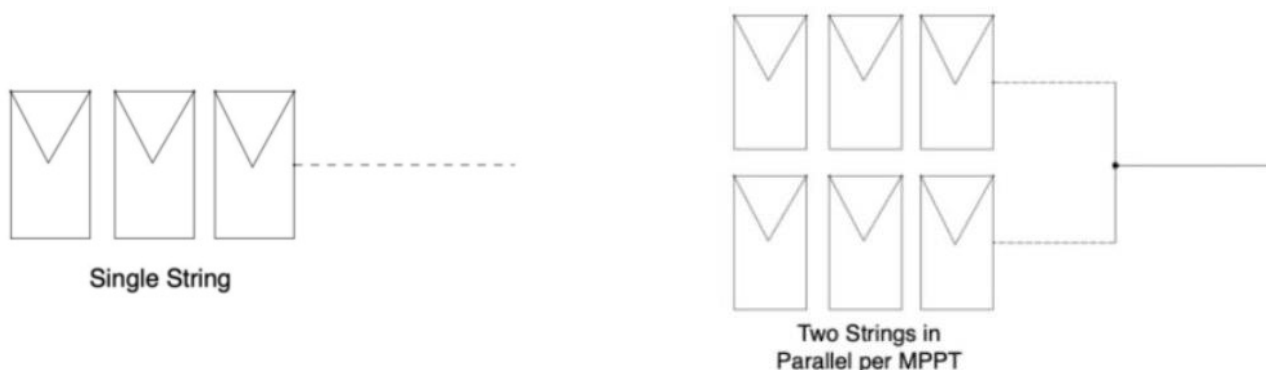


Figure 26 - Strings.

Before connecting to PV modules, install a separate DC circuit breaker between the inverter and PV modules.

To avoid any malfunction:

- Do not connect any PV modules with possible current leakage to the inverter. For example, grounded PV modules will cause current leakage to the inverter.
- The open-circuit voltage (Voc) of PV modules does not exceed the maximum PV array open-circuit voltage. This is extremely important.
- The open-circuit voltage (Voc) of PV modules should be higher than the minimum start voltage of the inverter.

IMPORTANT:

Voc voltage open circuit is King. Never exceed the maximum Voc voltage of 450 V.

A general rule is 0.6 V Per cell Voc, but you cannot take this as fact since some newer technologies may have higher voltages.

Do not rely on your multimeter to work out the Voc. You must also check with the solar panel ratings. By all means, double-check with your meter.

If there is no sunshine, then you may get a false reading. Also, pay attention to cold weather conditions because the Voc can increase dramatically. Again, please check with the solar panel manufacturer how was the performance in very cold weather, especially below zero. Warmer weather is less of a problem as panels give less power when hot.

WARNING:

If the voltage is too high on the MPPT, you can burn out the front-end. DC to DC converter damaging also invalidates your warranty.

Keep your Voc below 450V. Regardless of the power of the solar panel, the inverter will only draw what it needs (basic ohms law). Please refer to our training manual part one.

When wiring to strings in parallel, please make sure the strings have identical power, identical size, and identical manufacturer. Do not mix panels if one string is only 8 panels and the other 9. This will create an imbalance and cause major efficiency losses. However, you can mix panels between the MPPTs since both inputs work independently.

A common question often asked is: you have a lot of solar panels and the sun is shining, yet the array is not producing much power. To produce power, you must have to use the power that is producing. If you are not using the power, then they will simply not produce anything.

In this circumstance, check if your battery is full and the usage is minimal. Unless you switch the power to the smart load or export the power, it will simply be lost, and you will not be producing any little energy from your solar array. Refer to Aux Load output section.

Figure 27 shows the PV connection of the 8.8kW inverter while shows the 3.6kW/5.5kW PV connections. For this smaller version, the panels are connected via the MC4 connectors located at the bottom of the inverter, as presented in

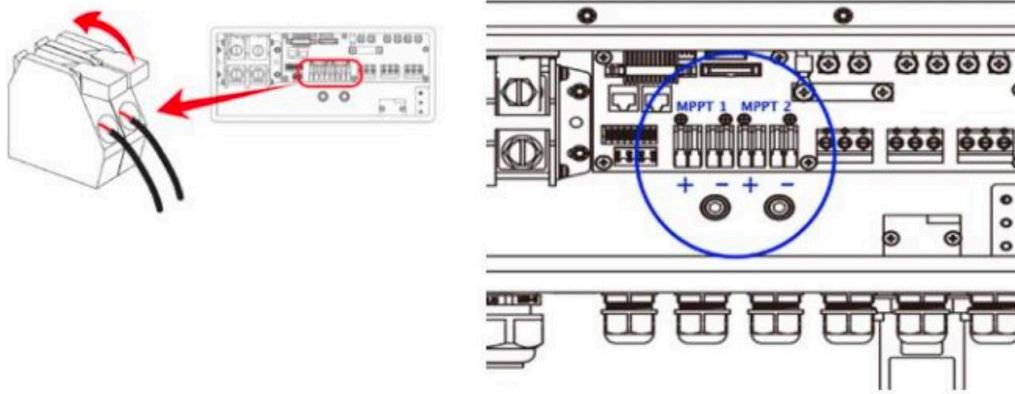


Figure 27 - PV connections of the 8.8 kW inverter.



Figure 28 - 3.6kW/5.5kW bottom view.

5. THE DISPLAY

The Sunsynk hybrid inverter has the most amazing navigation and information screens of any other inverter in its class.



Figure 29 – Amazing interface of the Sunsynk inverter.

Once the inverter has been properly installed and the batteries are connected, press the on/off button (located on the left side of underneath the case) to turn on the system. Many people often forget to switch on the inverter.

When the system is connected without a battery but connected with either PV or grid and the on/ off button is switched off, the LCD will still light up (display will show off). In this condition, when switching on the on/off button and selecting no battery, the system can still work.

5.1. HOME SCREEN

This is the first screen that you will see when the system is booted up. It is a very useful screen and was designed to give a lot of information in such a small area.



Figure 30 - Home screen.

What this page displays:

- Total daily power into the battery (kWh).
- Total daily power out of the battery (kWh).
- SOC (State of charge of the battery) (%).
- Total daily solar power produced in (kWh).
- Total hourly usage of the generator (Time).
- Total daily power sold to the grid (kWh).
- Total daily power bought from the grid (kWh).
- Real-time solar power in (kW).
- Real-time load power in (kW).
- Real-time battery charge power in (kW).
- Real-time grid power in (kW).
- Serial number.
- Time date.
- Fault condition.
- Access stats pages.
- Access status page.
- Access fault diagnostic page.

5.2. STATUS PAGE

To access the Status page, click on the 'Battery' or 'AC Load' dial on the Home page.

What this page displays:

- Total solar power produced.
- MPPT 1 power/voltage/current.
- MPPT 2 power/voltage/current.
- Grid power.
- Grid frequency.
- Grid voltage.
- Grid current.
- Inverter power.
- Inverter frequency.
- Inverter voltage.
- Inverter current.
- Load power.
- Load voltage.
- Battery power charge/discharge.

0 Watts 0.00 V 0.00 Amps 0.0 C	0 watts 0 Hz 0 Volts 0.0 Amps CT:0Watts LD: 0Watts	0 Watts 0.00 Volts 0.0 Amps
Battery	Grid Power	Solar Power 1
0 watts 0 Hz 0 Volts 0.0 Amps DC:100.0 C AC:100.0 C	0 Watts 0.00 Volts 0.0 Amps	0 Watts 0.00 Volts 0.0 Amps
Inverter Power	Load Power	Solar Power 2

Figure 31 - Status page.

- Battery SOC.
- Battery voltage.
- Battery current.
- Battery temperature.

Solar Column: Shows total PV power at the top and then details of each of the two MPPT's below L1 & L2 voltage.

Grid Column: Shows grid total power, frequency, voltage, and current. When selling to grid the power is negative. When receiving from the grid the power is positive. If the sign of the grid and HM powers are not the same when the PV is disconnected and the inverter is only taking energy from the grid and using the HM CT connected to Limit-2 then please reverse the polarity of the HM current sensor. **Important:** See section 3.3 about the CT coil.

Inverter Column: Showing inverter total power, frequency, L1, L2, voltage, current, and power.

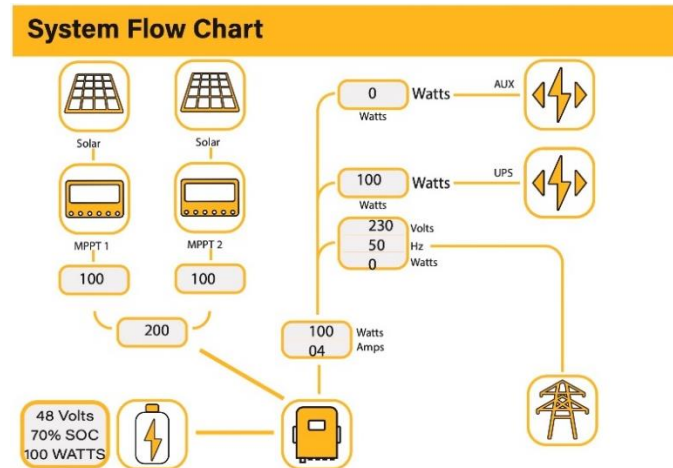
Load Column: Showing total load power, load voltage, and power on L1 and L2.

Battery Column: Showing total power from the battery, battery SOC, battery voltage, battery current (negative means charge, positive means discharge) battery temperature (shows zero if the battery

temperature sensor is not connected). DC transformer temperature and AC heatsink temperature (When the temperature reaches 90°C it will show in red and start deteriorating when it reaches 110°C. Next, the inverter will shut down to allow it to cool and reduce its temperature.

5.2. STATUS PAGE

Access by clicking on the bar chart on the home page.



What this page displays:

- The system flow.
- MPPTs power.
- Battery status.
- Power distribution to load or grid.

I personally think that this is one of the most useful pages to fully understand what the inverter is doing instantaneously. You can clearly see the status of charge and discharge, the battery condition, the exact current flow. This is a very useful screen and it is unique to the Sunsynk product.

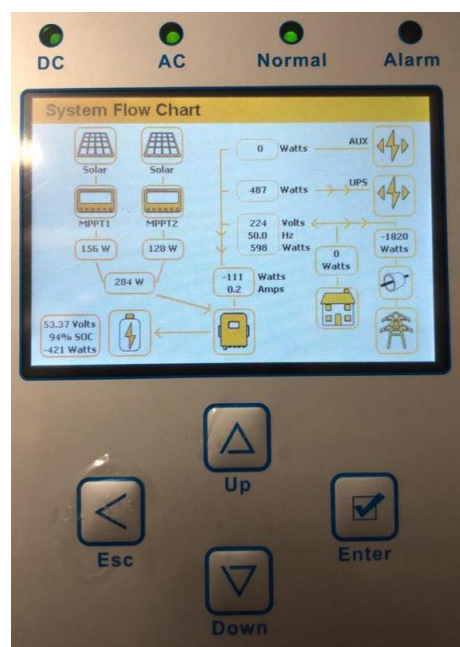


Figure 32 - Interface with the flow chart.

5.2. SET UP / PROGRAMMING PAGE

The three screens shown below are only a few among many information screens. Please refer to the user manual for the other information screens. Most of the programming screens can be accessed via the navigation screen.

To access the Setup Page, click on the gear icon on the right top of the navigation menu.

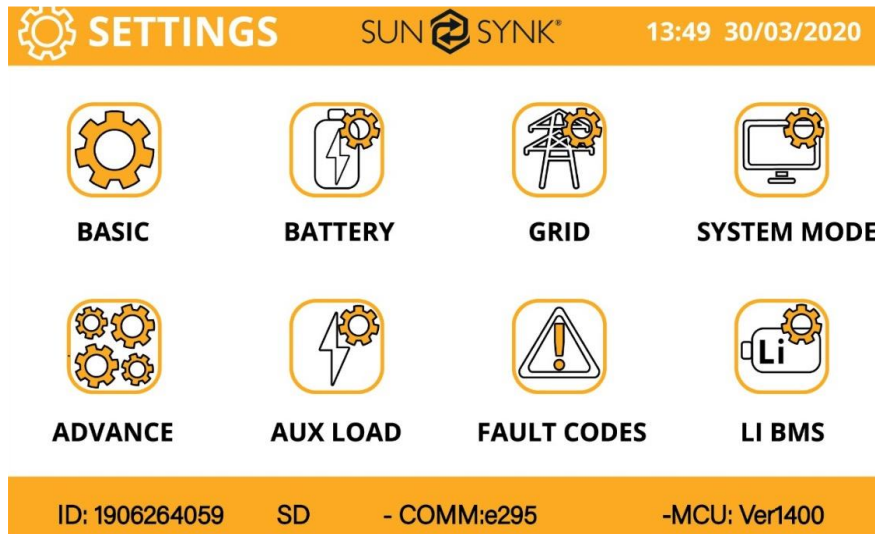


Figure 33 – Set up / Programming page.

From this page, you can select the system operating language (English, Spanish, French, and Portuguese), set up your own company name to be shown on the front screen or, if you are brave enough, your company phone number, and set up your battery type as lithium or AGM.

For this training manual, we are not going to discuss the set up slowly but some specific scenarios (for detail programming flow, please refer to the user manual).

6. OPERATION MODES

This section will discuss the general modes in which the inverter can be used.

Before we start this section, you must understand that the heart of the inverter is the controller; it controls everything. Therefore, if you can understand how the controller works, then you will start to appreciate the capabilities of this powerful machine.

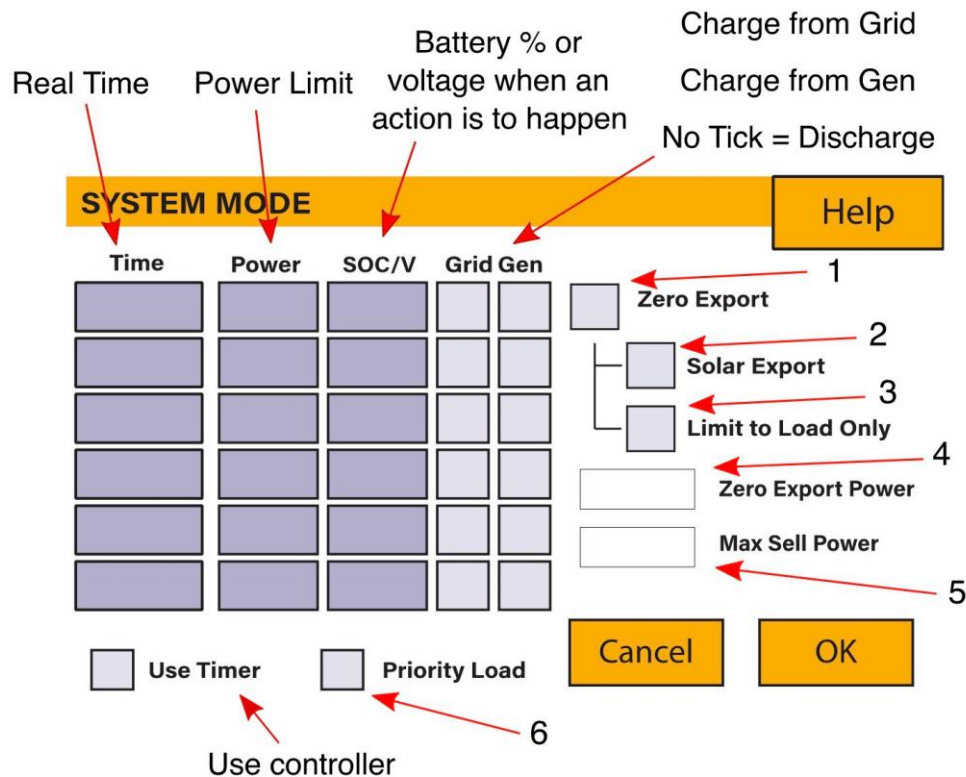


Figure 34 - System mode page.

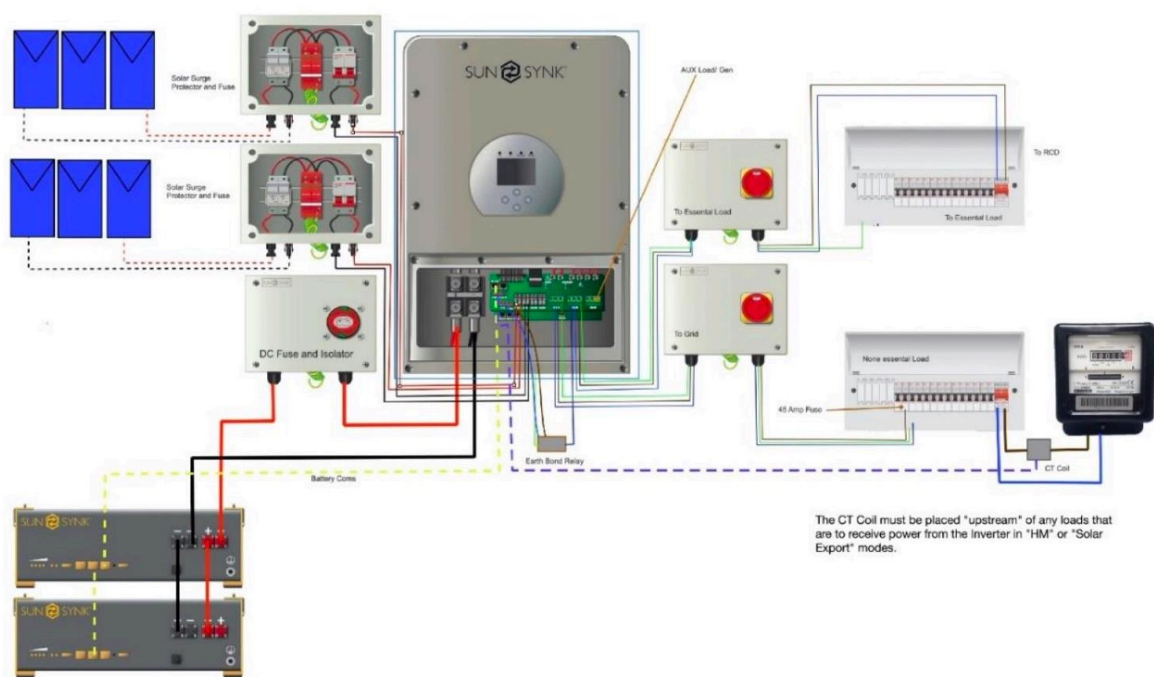
- 1) Tick this box to do not export power back to the grid (the CT coil will detect power flowing back to the grid and will reduce the power of the inverter only to supply the local load).
- 2) Tick this box if you wish to export your solar power back to the grid.
- 3) Tick this box if you only want to supply power to the load side of the inverter.
- 4) Zero export power is the amount of power flowing from the grid to the inverter. Set this value to 20 – 100W to force the inverter to always take this amount of power from the grid to minimise nuisance “Reverse Power Detection” tripping of sensitive prepaid electricity meters.
- 5) This controls the maximum overall power, both to the load and grid ports combined. It is set to low if an over current fault occurs.

- 6) Tick this box if you wish that the solar panels prioritize power to the load. But, if you untick the solar will prioritize the power to charge the batteries.

6.1. ON-GRID WITH NO PV

On-grid with no PV is very useful in parts of the world where the sunshine is very low and variable tariffs are applied. The main purpose of this mode is to store electricity at night, when it is cheaper, to use it during the daytime. The savings can be quite a lot of money.

Installing this type of system is very simple.



Connect the inverter to the grid, but do not forget to add the CT coil directly after the meter. If you want to have any UPS feature to connect essential loads, you can hook them up to the 'LOAD' connection. However, do not connect all your power here, just the lighting circuit and maybe a couple of plug sockets. In the case of mains failure, the main connection will not have power since it is AC coupled, but your essential loads will still operate.

PROGRAMMING:

- 1) **Basic Setup:** set up your time and date, the company name, and language.
- 2) **Battery Setup:** set up your battery type. Ensure that you have communication if you are using a lithium battery. Also, be sure you click the Grid on the battery set up, and set your battery charging current according to the type of battery you are using. Generally, if you are using a lithium battery with communication cables to the BMS, it will be automatically set for you.
- 3) **Grid Setup:** set your grid parameters if required. In most cases, the default setting will be enough - no need to touch it.
- 4) **Aux Load Setup:** no need to touch Aux/Load or advanced settings. These are for other features.
- 5) **LI BMS Setup:** this is an information page to show whether the communication is working correctly or not with the battery. See previous notes.
- 6) **System Mode Setup:** this is the heart of the system. It is actually the controller that makes everything come together.

For this application, you need to program the controller to charge the batteries at night and discharge during the daytime. Remember, **BBGAs:** Basic, Battery, Grid, Advance, Controller.

SYSTEM MODE Help

Time	Power	SOC/V	Grid	Gen
24:00	2000 W	100%	<input checked="" type="checkbox"/>	<input type="checkbox"/>
06:00	2000 W	20%	<input type="checkbox"/>	<input type="checkbox"/>
			<input type="checkbox"/>	<input type="checkbox"/>
			<input type="checkbox"/>	<input type="checkbox"/>
			<input type="checkbox"/>	<input type="checkbox"/>
			<input type="checkbox"/>	<input type="checkbox"/>

Zero Export

Solar Export

Limit to Load Only

100 W Zero Export Power

3500 W Max Sell Power

Use Timer Priority Load

Cancel OK

Figure 35 – On-grid with no PV example.

- 1) Select use timer and then select to charge time maximum charge power and the percentage clients want the battery to reach.
- 2) Select discharge time, maximum discharge power, and maximum depth you allow the battery to go to. Do not touch any boxes at this point.
- 3) As you are not exporting any power, tick 'Zero Export'.
- 4) Zero export power is a small trickle power that will come from the grid to prevent any export.
- 5) The maximum sell power is, in fact, the maximum power of the inverter.

6.2. ON-GRID WITH UPS

There are two ways to do this: you can either use a single inverter or two inverters, depending on how stable you want the power to be. The simplest form is using a single or multi inverter system.

Most of the time, the supply is coming directly from the grid. But, when the grid fails, it will automatically switch over to battery even though there is a very short delay of milliseconds for this switching.

In this application, all the power is provided to the load from the grid. **Except, if there is a grid failure.** In a simple form: the 'GRID' is the input 'LOAD' is the output.

IMPORTANT:

Unlike the AC coupled application, your power is limited to the maximum power of the inverter. Ensure that the inverter rating matches your load.

PROGRAMMING:

The programming is still very simple:

- 1) **Basic Setup:** set up your time and date, the company name, and language.
- 2) **Battery Setup:** set up your battery type. Ensure that you have communication if you are using a lithium battery. Also, be sure you click the Grid on the battery set up, and set your battery charging current according to the type of battery you are using. Generally, if you are using a lithium battery with communication cables to the BMS, it will be automatically set for you.

- 3) **Grid Setup:** set your grid parameters if required. In most cases, the default setting will be enough - no need to touch it.
- 4) **Aux Load Setup:** no need to touch Aux/Load or advanced settings. These are for other features.
- 5) **LI BMS Setup:** this is an information page to show whether the communication is working correctly or not with the battery. See previous notes.
- 6) **System Mode Setup:** this is the heart of the system. It is actually the controller that makes everything come together.

The screenshot shows the 'SYSTEM MODE' configuration interface. It features a yellow header bar with the title 'SYSTEM MODE' and a 'Help' button. Below the header is a grid of 6 rows and 5 columns. The columns are labeled 'Time', 'Power', 'SOC/V', 'Grid', and 'Gen'. To the right of the grid are several settings: 'Zero Export' (checked), 'Solar Export' (unchecked), 'Limit to Load Only' (checked), 'Zero Export Power' (100 W), and 'Max Sell Power' (3500 W). At the bottom are 'Use Timer' (unchecked), 'Priority Load' (unchecked), 'Cancel', and 'OK' buttons.

Figure 36 - On-grid with UPS example.

In this application, there is no need to use the timer. You must tick the 'Zero Export' box and set the Zero Export Power. In addition to that, you need to tick 'Limit power to load only', and set the inverter power.

6.3. USING A GENERATOR – WIRING / COMMON ISSUES / PROGRAMMING

Using a generator with the system hybrid inverter is very common. If you are using a single inverter, you have two choices: wire the generator to the Gen/Aux input or connect it to the main input..

IMPORTANT:

If you are using multi inverters, then you cannot connect the generator port to the 'GEN/AUX' port. This is because it can cause an imbalance. For example, if you have three inverters on three-phase and try to use

the generator ports in one of them, one of the inverters could reverse and cause a huge problem. Do not do it this. **Note:** our software will actually prevent this from happening. It just simply will not work.

The generator could be either configured to automatically start-up by the generators A/T/S when the batteries are low or done manually.

PROGRAMMING:

Let's look at the setting for an automatic A/T/S:

- 1) **Basic Setup:** set up your time and date, the company name, and language.
- 2) **Battery Setup:** set up your battery type. Ensure that you have communication if you are using a lithium battery. Also, be sure you click the Grid and/or Gen on the battery set up, and set your battery charging current according to the type of battery you are using. Generally, if you are using a lithium battery with communication cables to the BMS, it will be automatically set for you.

If you're using the generators A/T/S then you must tick the box to send charge signal.

IMPORTANT:

Some generators can only be run for a certain amount of time, and then they need to cool down. This can be set on the Battery Setup page, shown in

Battery Setup		Help
Batt type	Batt Charge	Shut Down
Amps	50 A	50 A
<input checked="" type="checkbox"/> Gen Charge	<input checked="" type="checkbox"/> Grid Charge	Float V
<input checked="" type="checkbox"/> Gen Signal	<input checked="" type="checkbox"/> Grid Signal	Absorption V
<input type="checkbox"/> Signal Island Model		Equalization V
GEN MAX RUN TIME	0.0 hours	0 days
GEN DOWN TIME	0.0 hours	0.0 hours
	Cancel	OK

Figure 37 - Battery Setup page.

- 3) **Grid Setup:** set your grid parameters if required. In most cases, the default setting will be enough - no need to touch it.

4) **Aux Load Setup:** if you are using a generator via this por you will need to click 'Gen input'.

The screenshot shows the 'AUX Load' configuration window. It features a yellow title bar with the text 'AUX Load' and a 'Help' button on the right. The main area contains several settings: a checked radio button for 'Gen input', an unchecked radio button for 'Aux load output', and an unchecked radio button for 'For Micro inverter input'. To the right of these are 'Gen peak shaving power' (1000W) and 'MI Zero Export' (unchecked). Below these are 'Aux Load OFF Batt' (95%), 'Aux Load ON Batt' (100%), and 'Solar Power(W)' (1000W). At the bottom, there are 'Cancel' and 'OK' buttons.

Figure 38 - Aux Load page.

- 5) **LI BMS Setup:** this is an information page to show whether the communication is working correctly or not with the battery. See previous notes.
- 6) **System Mode Setup:** this is the heart of the system. It is actually the controller that makes everything come together.

When wiring the generator, you can connect it to the 'GRID' input via a changeover switch or a contactor. In this case, sometimes, you can have the grid, and sometimes you will only have the generator.

Your non-essential loads will be connected both to the grid side and the generator side. On the other hand, your essential loads will still come out of the 'LOAD' connection.”

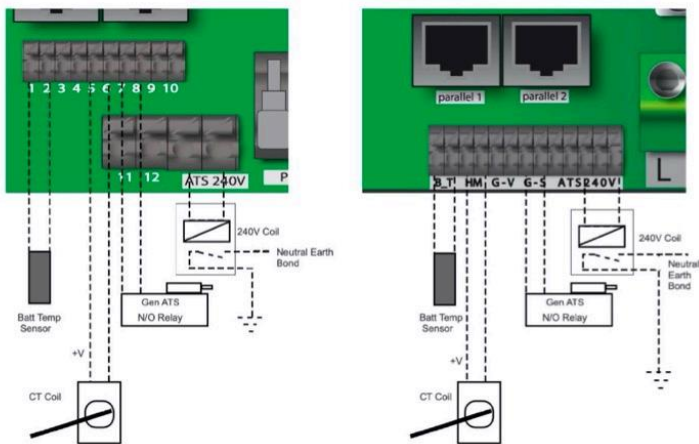
IMPORTANT:

- 1) You must connect the CT coil before the generator connection to ensure there is no feedback into the generator because it can be damaged.
- 2) The generator rating needs to be big enough to supply both the essential and non-essential loads and charge the batteries. Ensure that the generator has a large enough rating because, if it is underpowered, then the generator may slow down when switching in. This causes a frequency shift that will shut the inverter down, which can be very annoying as this will happen repeatedly.

In order to help the generator on a sudden surge current, the Sunsynk inverter steps up the charge current to the battery, but it will be providing the full load on switchover.

If your generator is not powerful enough to supply the full load and surges, you could choose to use a separate battery charger, charging the batteries directly. I often recommend using a second inverter or a standalone inverter in battery charge mode.

This inverter will be connected in parallel on the battery bus bar only to charge the battery when required or assist the battery charging. It is not connected in parallel with other inverters; this inverter is only connected to the battery. But, the MPPT is of this inverter can still be used for charging.



The generator relay on the inverter can automatically start a generator. However, the generator must have a suitable A/T/S.

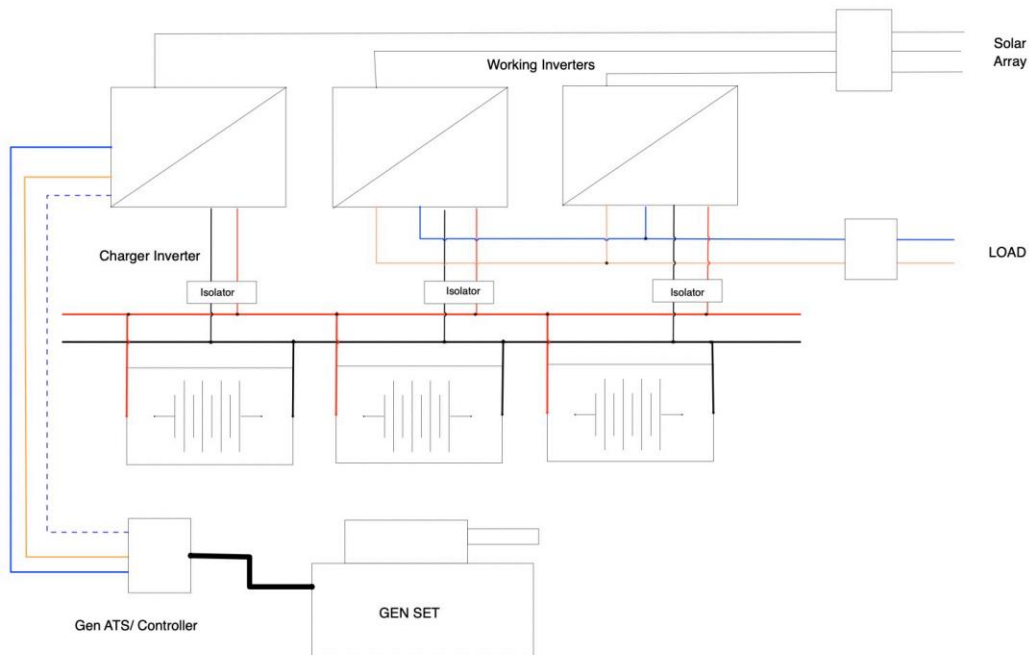


Figure 39 - Example of two working inverters and a charger inverter.

The above reference circuit is using one inverter as a charger and two inverters are supplying the load. This configuration gives you a much more stable supply and reduces the size of the required generator. The generator would never see any large surge current.

Note: The home screen will display the generator running time. It will not display the amount of power produced by the generator because there is no method to measure it.

6.4. EARTH CONNECTION (MANDATORY)

Ground cable shall be connected to ground plate on grid side this prevents electric shock. If the original protective conductor fails.

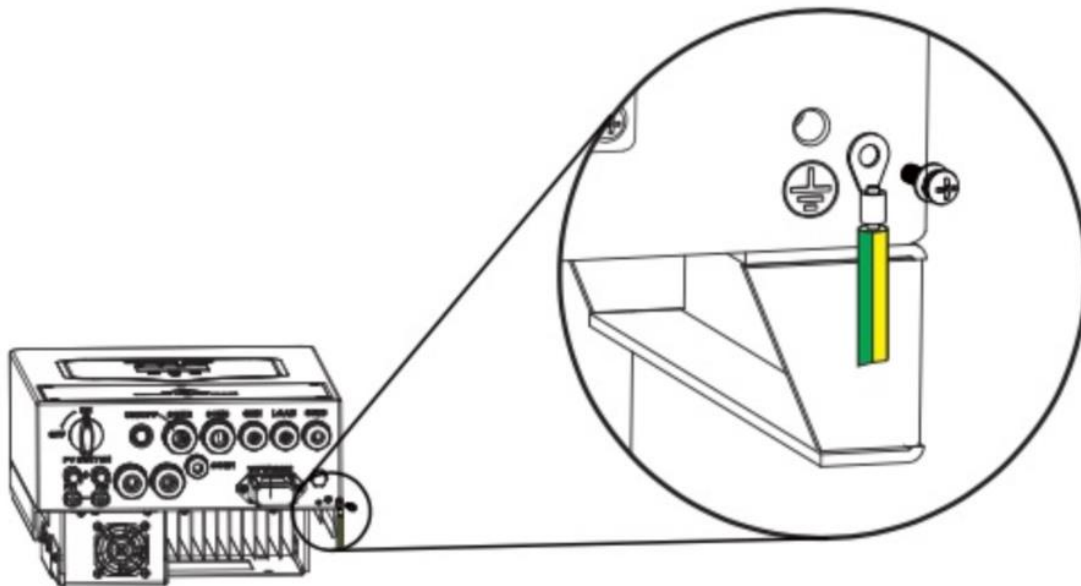


Figure 40 - Ground connection.

All neutrals can be linked together to maintain the neutral bond. When Neutral Earth bond is required for off-grid, then it has to be removed on grid-tied operation.

The unit must be correctly grounded, and the supply line must be equipped with a suitable breaker and residual current devices (RCDs) to protect people.

If an external RCD is used, a device of type (A/AC, etc.) should be employed, with a tripping current of 30mA.

Use of RCDs:

An RCD dedicated for an integrated electrical service (IES) may be used to meet the mechanical cable protection requirements and isolation requirements of AS/ NZS3000 for the cable from the switchboard to the IES. If an RCD is used, the RCD shall.

Table 3 - RCD.

Earth-leakage protection class	Type A
Earth-leakage sensitivity	30mA
Curve code	C
Network type	AC
Poles description	2P
Earth-leakage protection time delay	Instantaneous

- 1) Disconnect all live conductors (including the actives and neutral);
- 2) Check type specified in the inverter manufacturer's instructions or as labelled on the inverter.

We recommend the use of an RCD on all circuits and sub-circuits connected to the Sunsynk inverter - a residual current breaker with overcurrent protection (RCBO).

6.4.1. EARTH BOND RELAY

If an earth bond is required between neutral and earth, and your system is a hybrid system, then you can have a permanent earth wire, since this can cause faults with an RCD before the inverter.

Since the inverter is a true hybrid then the bond must only be made when the inverter is operating in Islanding Mode. To accommodate this, Sunsynk provides an AC output, which is connected to the A/T/S connections whenever the inverter is running on Island Mode. Therefore, you can simply connect the coil of an AC relay to the ATS 240 connections. Next, you need to select Signal Island Mode on the battery charge menu (click on the gear icon, then on the battery icon), as shown in Figure 41.

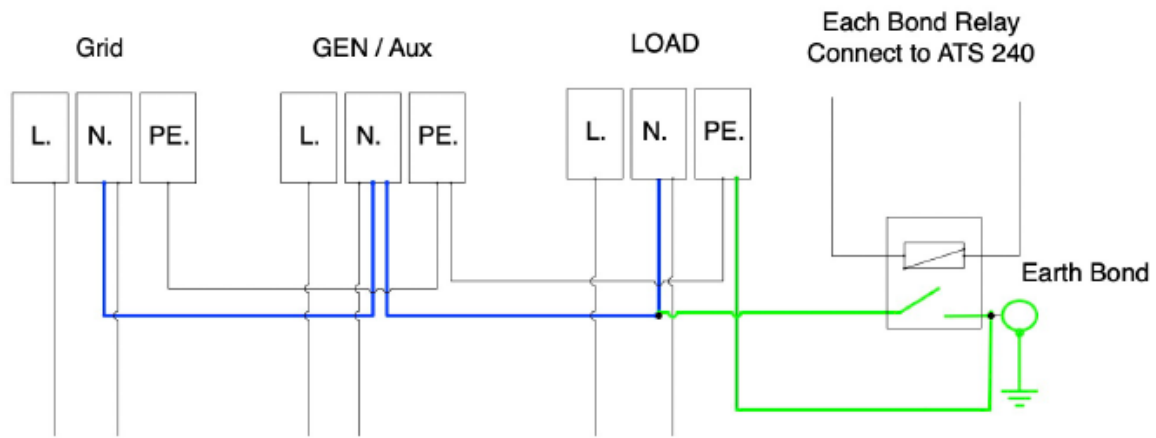


Figure 41 - Earth bond.

Note: You will only use this feature if you are not using the 'GEN/AUX' connection.

To use this feature, you will tick 'Signal Island Mode', as presented in Figure 42.

Battery Setup		Help
Batt type	Batt Charge	Shut Down
Amps	<input type="text" value="0A"/> <input type="text" value="0A"/>	Float V <input type="text" value="0.0V"/>
<input type="checkbox"/> Gen Charge	<input type="checkbox"/> Grid Charge	Absorption V <input type="text" value="0.0V"/>
<input type="checkbox"/> Gen Signal	<input type="checkbox"/> Grid Signal	Equalization V <input type="text" value="0.0V"/>
<input checked="" type="checkbox"/> Signal Island Model		<input type="text" value="0 days"/>
		<input type="text" value="0.0 hours"/>
GEN MAX RUN TIME	<input type="text" value="0.0 hours"/>	<input type="button" value="Cancel"/> <input type="button" value="OK"/>
GEN DOWN TIME	<input type="text" value="0.0 hours"/>	

Figure 42 - Signal island mode.

The grid may still be present, but the inverter is not draining power from it since the unit is working in Island Mode.

6.5. AUXILIARY / SMART LOAD

The auxiliary load function can be set by click on the 'Aux Load' icon on the settings page. This is a wonderful feature when the batteries are fully charged and the inverter is still producing energy from the PV.

By ticking 'Aux load output', you can divert the power to your water heater, air-conditioner, or another auxiliary load.

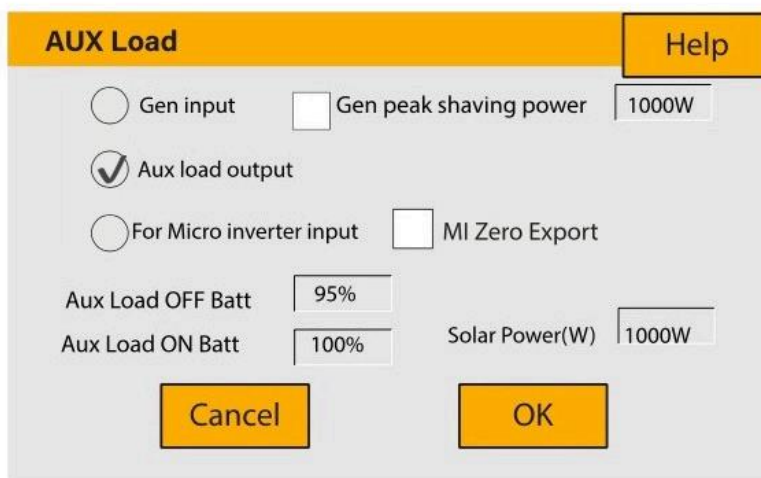


Figure 43 - Aux load in use.

On this page, you can also use the input for microinverters and set them with zero export. Even if the inverter is off-grid/island mode, you can still use my converters up to a maximum of 4kW extra on the 8.8kW unit.

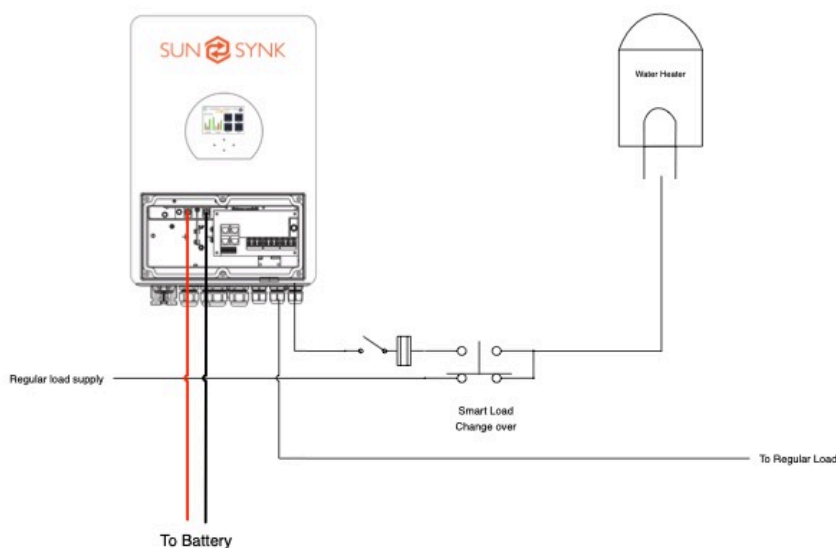


Figure 44 - Aux load diagram.

This is also a very good feature when using the wind turbine, the auxiliary/smart loads, and also for using it as a dump load if necessary.

The controls presented in Figure 43 control the SOC level when the Aux load switches on and the SOC when the smart load switches off.

The energy powering the Aux load will be powered from the inverter directly and the solar power setting is the power limiter to the Aux load. If you set this to 1000, the inverter will deliver up to 1000W depending upon your load. This value is not limited by the power of the solar panel or wind turbine but rather than the power in the battery.

6.6. PEAK SHAVING

Peak Shaving is a technique used to reduce electrical power consumption during periods of maximum demand on the utility grid. Thus, one can save substantial amounts of money due to peaking charges.

Also, this technique has another usage when used with the generator. You can use a much smaller generator is running continuously, and the inverter takes up the peak demand.

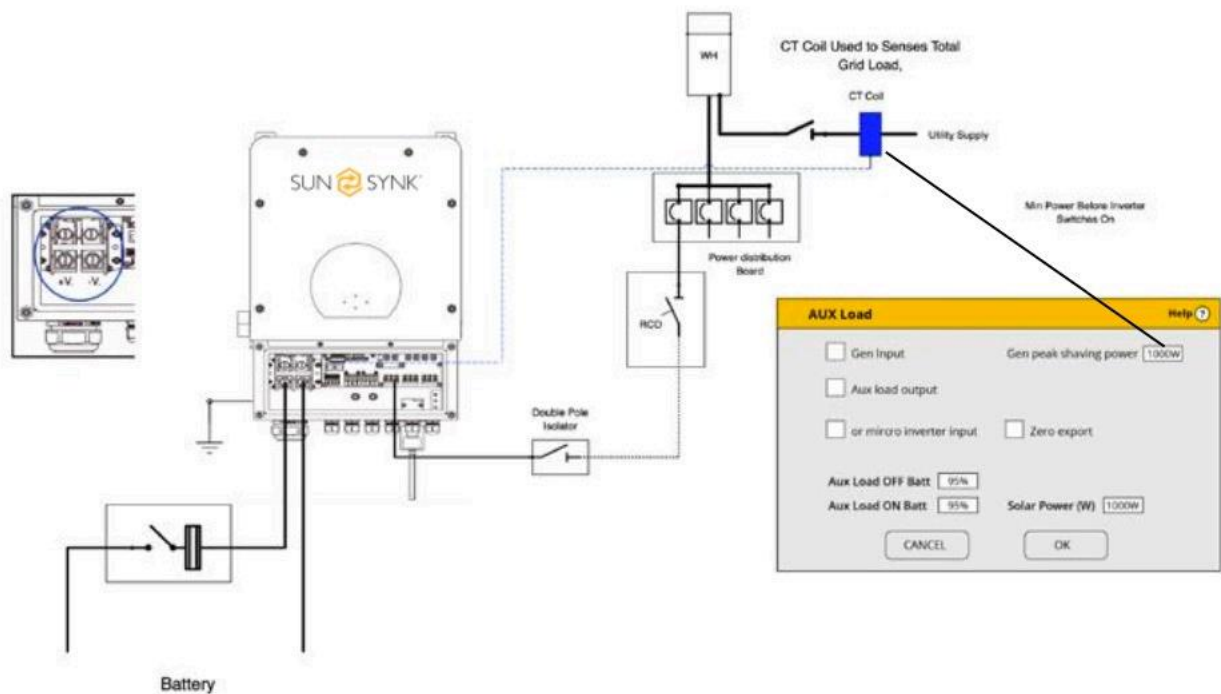


Figure 45 - Peak shaving.

This is very useful in grids with massive surplus charges for overuse of energy or in areas where you have a limited power supply. For example, you may only have a 10A supply, but you may require 20A, 30A, or more. Therefore, the inverter can be used to take up the exceeding power when it is required.

For peak shaving applications, the CT coil is used to measure the load on the system and to supply the extra power when needed.

In the Aux Load page, you can select the level when the power shaving starts and the amount of power that the inverter will deliver. Also, do not forget that you need to set the global inverter level on the controller page.

The screenshot shows the 'AUX Load' configuration window. It features a yellow title bar with the text 'AUX Load' and a 'Help' button on the right. Below the title bar, there are three radio button options: 'Gen input' (which is selected), 'Aux load output', and 'For Micro inverter input'. To the right of the 'Gen input' option, there is a checked checkbox for 'Gen peak shaving power' and a text input field containing '1000W'. Below these options, there is an unchecked checkbox for 'MI Zero Export'. Further down, there are two text input fields: 'Aux Load OFF Batt' with the value '95%' and 'Aux Load ON Batt' with the value '100%'. To the right of these, there is another text input field for 'Solar Power(W)' with the value '1000W'. At the bottom of the window, there are two yellow buttons: 'Cancel' on the left and 'OK' on the right.

Figure 46 - Peak shaving setting.

6.7. WIND TURBINES



The Sunsynk inverter has been tested with various wind turbines. To connect to a wind turbine, you need to add a connection box, which rectifies the three-phase AC of the wind turbine, adds some limitation, and allows you to connect the turbine to the MPPT directly. This is presented in Figure 47.

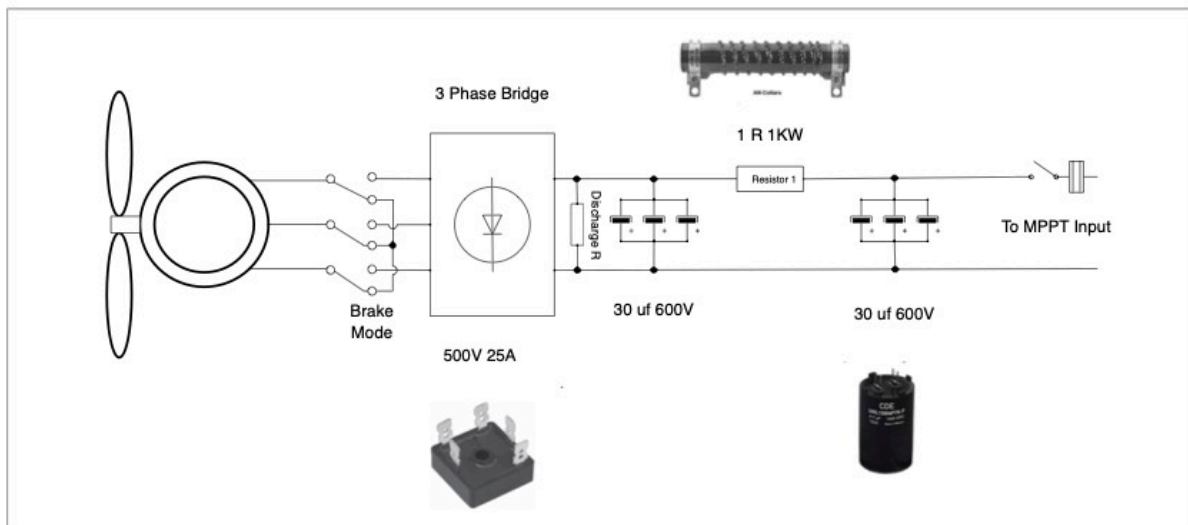


Figure 47 - Wind turbine combiner box.

IMPORTANT:

If you use the wind turbine with the Sunsynk inverter, you must ensure that the turbine matches the specifications of the product. You need to use a three-phase p.m. type, with a running voltage of around 200V and a maximum voltage and power of 350V/400V and 5 kW, respectively. Moreover, we strongly recommend using automatic self-breaking wind turbines because when are fully charged and the inverter is not exporting any power, the load can drop. This can cause the turbine to speed up dramatically, which can be very dangerous and usually happens suddenly. Thus, it is essential to use a self-breaking turbine.

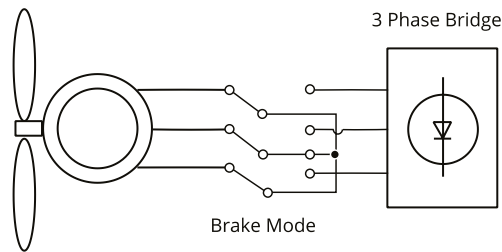


Figure 48 - Wind turbine with self-breaking.

To use the wind turbine, you need to set the wind turbine profile as presented in Figure 50. Again, DO NOT use a wind turbine that exceeds 350/400V.

Figure

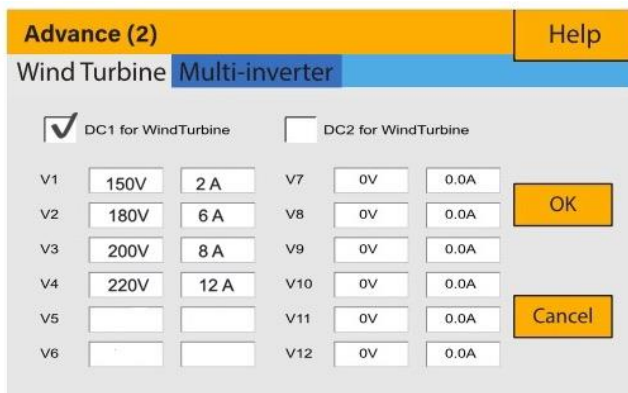


Figure 50 - Wind turbine configuration.



Figure 49 - Dump load.

Dump Load: When the battery (battery bank) is fully charged and the water turbine/wind turbine/solar module is still generating power, a dump load will provide the electricity a path to flow. This can be done using a switch on the smart load option or utilizing a wind turbine controller with a built-in dump load. Also, the hot water tank controlled via smart load can act as a good dump load, but it may be necessary to shunt the output in very windy conditions.

7. PARALLELING INVERTERS



Figure 51 - Installation with many inverters.

To configure multi-inverter settings, click on the 'Advance' icon.

A screenshot of a web-based configuration interface. The title bar is yellow and contains 'Advance (1)' and a 'Help' button. Below the title bar, there are two tabs: 'Wind Turbine' and 'Multi-inverter', with 'Multi-inverter' selected. The main area contains several settings: a checked checkbox for 'Parallel', radio buttons for 'Master' (selected) and 'Slave', a 'Modbus SN' field with the value '01', and radio buttons for 'A Phase' (selected), 'B Phase', and 'C Phase'. At the bottom, there are two yellow buttons: 'Cancel' and 'OK'.

Figure 52 - Paralleling inverters page.

For stability, all the batteries need to be connected in parallel. It is recommended a minimum cable size of 50mm diameter with fuse isolators to each inverter.

When connecting inverters in parallel, there are some important points that you must remember:

- 1) You can only connect the 'GRID' input and 'LOAD' output in parallel.

- 2) Do not connect the 'AUX/Gen' input in parallel. This input can be used for Aux /smart load if required, but it is generally better not to use.
- 3) Ensure there is a good communication cable between each inverter and always set the master inverter centrally, as shown in Figure 53.

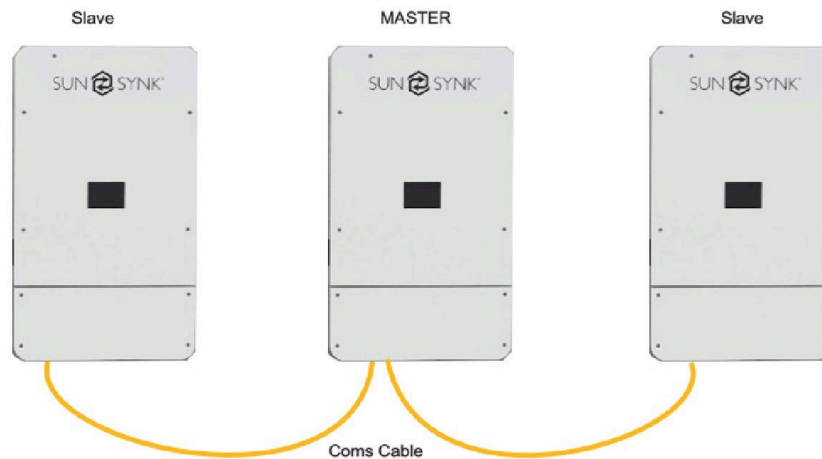
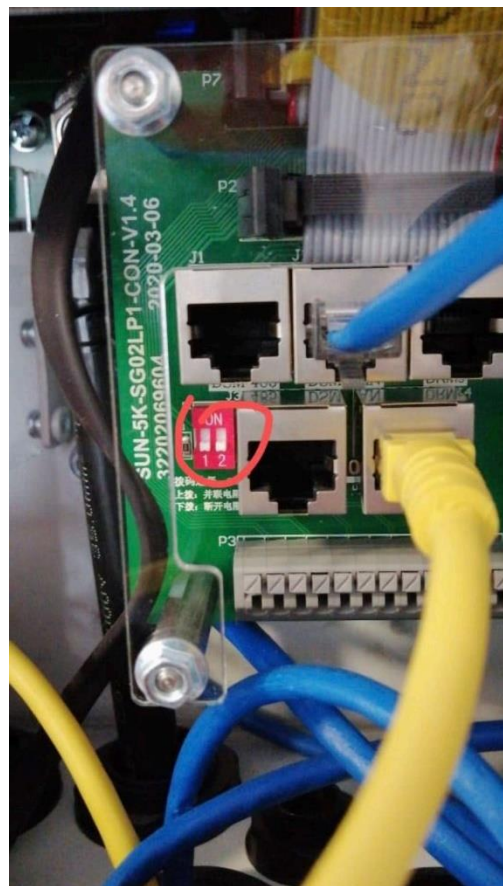


Figure 53 – Paralleling inverters.

- 1) All batteries must be in parallel.
- 2) Inverters operating without batteries are only in grid operation, so they do not need to be paralleled in the same way.
- 3) You only need one CT coil pair master.
- 4) Only the master can communicate with the battery array. However, suppose you are using more batteries than the allowable for the inverter. In that case, the other batteries can be connected to the other inverters set to voltage only, and no need for communication.
- 5) If the inverters are connected to the communication of the same battery array, the master will control the charges in the other inverters.
- 6) When connected to a generator, do not connect the communication cable if you are using the inverter as a charger. Consider it as a standalone inverter.
- 7) If using a single-phase, you only have one master and one CT coil.
- 8) If using three-phase, you need three masters and three CT coils.
- 9) Remember that each inverted needs its own data logger.

- 10) All inverters must be identical, so do not mix up types or software.
- 11) If you are unsure about the installation, please double-check with Sunsynk and check if you have the latest operating system. It is worth it carrying out an upgrade before you complete the final installation.
- 12) The most common problem with wiring inverters in parallel is the communication cable F29 Error.

If using more than 3 inverters in parallel, you need to remove the resistors on the communication ports. You can do this via a small dip switch located close to the parallel input, as shown in Figure 53 .



ON: 1 1

OFF: 0 0

Figure 54 - Dip switch.

7.1. SINGLE-PHASE CONFIGURATION

In theory, you can connect up to 16 inverters on the single-phase configuration, but be very careful about the inrush current when switching on. You may need to add an additional contactor.

The single-phase configuration only requires one master, and all the others are slaves. In addition, keep the communication cable as short as possible.

- 1) Check if all inverters have the same operating system and the latest software version and are the same model.
- 2) On the multi inverter page, select 'parallel' and choose the master, which is normally the central inverter.
- 3) Ensure that you have good quality communication cable between the inverters.
- 4) Set all the other inverters to be slaves
- 5) Each inverter needs its own unique Modbus number.
- 6) Each inverter needs its own data logger.
- 7) You only need one CT coil, which is connected to the master.
- 8) All batteries are wired in parallel.
- 9) The master is the only one that communicates with the battery BMS.

After checking and setting all this, you are good to go. As aforementioned, the most common fault is a communication error between the inverters. Please study the previous Section 7 of this training manual.



Figure 55 - Sunsynk inverters paralleled.

7.2. THREE-PHASE CONFIGURATION

The Sunsynk hybrid inverter can also be paralleled in three-phase with perfect phase rotation. In this case, you need to have three masters, and all the others are slaves. DO NOT forget that each inverter still needs its own unique Modbus communication number.

- Phase A: Master A and Slave A
- Phase B: Master B and Slave B
- Phase C: Master C and Slave C

- 1) Check if all inverters have the same operating system and the latest software version and are the same model.
- 2) On the multi inverter page, select 'parallel' and choose the master, which is normally the central inverter.
- 3) Ensure that you have good quality communication cable between the inverters.
- 4) Set all the other inverters to be slaves
- 5) Each inverter needs its own unique Modbus number.
- 6) Each inverter needs its own data logger.
- 7) You only need one CT coil, which is connected to the master.
- 8) All batteries are wired in parallel.
- 9) The master is the only one that communicates with the battery BMS.

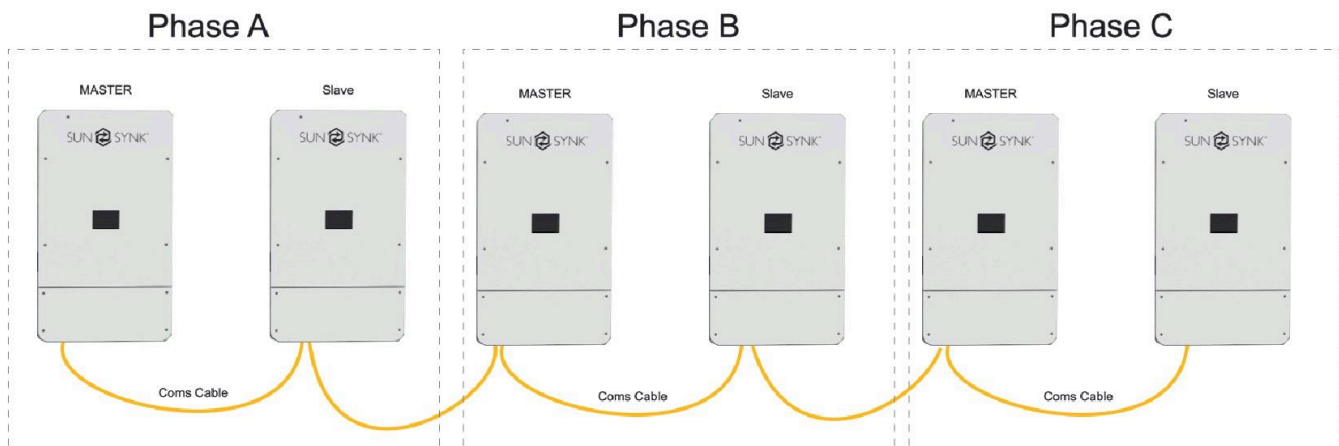
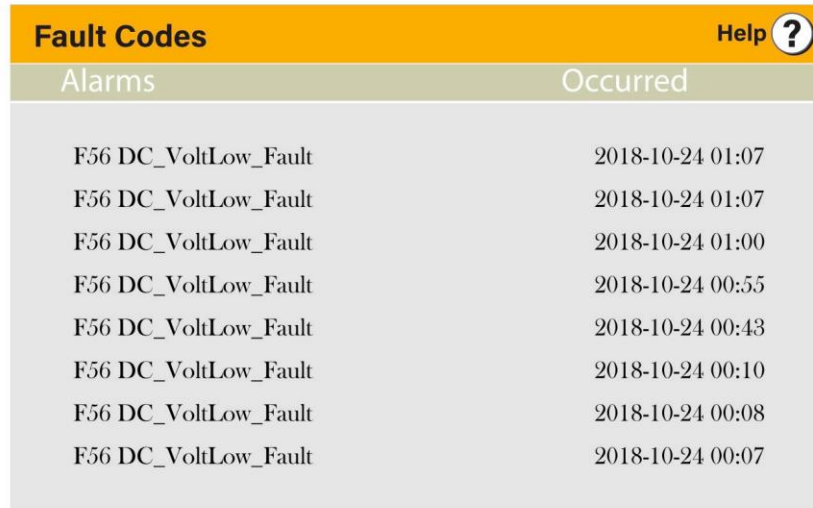


Figure 56 - Six inverters paralleled.

You can run a much larger system using many inverters. But, you need to split the loads, which is a good idea. Anyway, you can have a common battery bank, so the solar array charges the same battery.

Something to remember is that the inverters go through very stringent tests at our factory. They are tested for everything, as well as long soak tests. When the inverter leaves the factory, it is working perfectly. Therefore, any faults that appear are probably caused by installation issues.

To check fault codes, click on the 'Fault Codes' icon on the settings menu.



Alarms	Occurred
F56 DC_VoltLow_Fault	2018-10-24 01:07
F56 DC_VoltLow_Fault	2018-10-24 01:07
F56 DC_VoltLow_Fault	2018-10-24 01:00
F56 DC_VoltLow_Fault	2018-10-24 00:55
F56 DC_VoltLow_Fault	2018-10-24 00:43
F56 DC_VoltLow_Fault	2018-10-24 00:10
F56 DC_VoltLow_Fault	2018-10-24 00:08
F56 DC_VoltLow_Fault	2018-10-24 00:07

Figure 57 - Fault code pages.

The default diagnostic is here to help you find problems with the system. It is very useful in localising an issue.

F13 - Working mode change

If you are making a change while the system is running, like parallel or disabling the parallel operation, it may cause the system to crash. This is actually a very dangerous problem and can easily damage the inverter.

If you are making such changes, you need to isolate the inverter from the load. When the battery mode was changed to 'No battery' mode, it will report F13.

If you get an F13 fault, the best solution is normally to reset the system.

F18 AC - over current fault of the hardware

This error is an overload on the 'Load' terminal, and it is also quite a common fault. This fault is possibly caused by a heavy surge current from air-conditioners or by a battery issue. But, generally, it is caused by a rush current to the load due to many loads switching on at the same time.

We have had experienced that people have had F-18 faults during the night, often caused by a heavy inrush current caused by many electronic devices switching on together.

You need to separate your essential and non-essential load. Only connect essential loads to the 'Load' input and non-essential loads to the 'Grid' port.

Remember that the inverter sends power from both the 'Grid' connection and the 'Load' connection.

F20 - DC over current fault of the hardware

This error is usually caused by the battery not being able to deliver current to the inverter. There is an overcurrent on the battery. A high current overload on startup may also cause this cause fault.

To clear this fault, you must focus on the battery and battery discharge settings.

You need to check the C rating of the battery. If the battery cannot provide current sufficient for the 8.8kW inverter, it simply crashes out.

- 1) Check the battery C rating.
- 2) Check the maximum discharge current on the inverter settings.
- 3) Check the maximum power that the inverter can supply, which is a global setting that you can set on the main controller.
- 4) Check if the battery cables are heavy enough to meet the current demand.

F23 - AC leakage current or transient over current

This error is a fault on the main side that causes an earth leakage trip from the PV.

- 1) Double-check all your main cables coming in and make a mega test or installation test on the cables to ensure there is no leakage.
- 2) Check the PV ground connection.

- 3) Reset the system.

F24 - DC insulation impedance failure

This error is caused by an earth fault on the solar panel, which means that the positive or negative solar cable is touching the ground. This problem can be very dangerous.

To clear this fault, you will need to check each solar panel/array to isolate the fault.

F26 - The DC busbar is unbalanced

The inverter will report the F26 error when the hybrid is in split-phase mode, and the load of L1 and L2 are very different, which will damage the IGBT.

F29 - Parallel communication cable fault

This error is a very common fault when connecting inverters in parallel. Basically, it means that the communication cable is not working correctly. This problem can be caused by a wrong type of communication cable, wrong connection on the communication cable plugs, poor quality cable, or an incorrect setting on the inverter(s). Another cause can also be the in-line resistor is set incorrectly.

- 1) If you experience this fault, I suggest you follow these steps:
- 2) Switch off all inverters and reset them.
- 3) Check if each inverter has the correct and same operating system.
- 4) Check if the models are all the same.
- 5) Replace the communication cable with shorter cables. If possible, ensure that the middle inverter is the master and the other are slaves, which keeps the communication cable as short as possible.
- 6) Check if the port limiting resistors are set correctly.
- 7) Check if all your batteries are on the same bus bar.

F35 - No AC grid

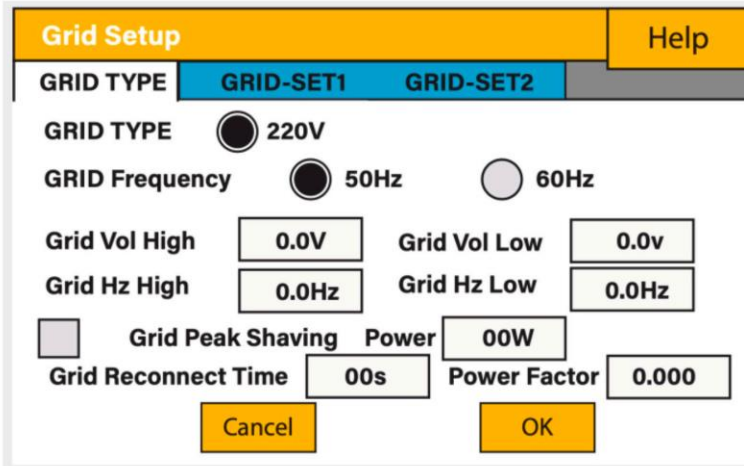
This is a simple error that occurs when no AC grid is present, so there is no power coming into the system.

You need to find the fault in your AC supply.

F42 - AC line low voltage

The AC upper and lower voltages are controlled by the Grid Setup page.

If you are experiencing the F42 fault, I suggest that you adjust better the high and low grid voltages on the Grid Setup page.



The screenshot shows the 'Grid Setup' interface with the following settings:

- GRID TYPE:** GRID-SET1 (selected), GRID-SET2
- GRID TYPE:** 220V (selected)
- GRID Frequency:** 50Hz (selected), 60Hz
- Grid Vol High:** 0.0V
- Grid Vol Low:** 0.0v
- Grid Hz High:** 0.0Hz
- Grid Hz Low:** 0.0Hz
- Grid Peak Shaving Power:** 00W
- Grid Reconnect Time:** 00s
- Power Factor:** 0.000

Buttons: Cancel, OK, Help

Figure 58 - Grid setup page.

If you are continually experiencing it, it may be worthwhile to fit a data logger to see what is actually happening with the mains and contacting the power utility company because this is actually a problem with the supply coming into the property.

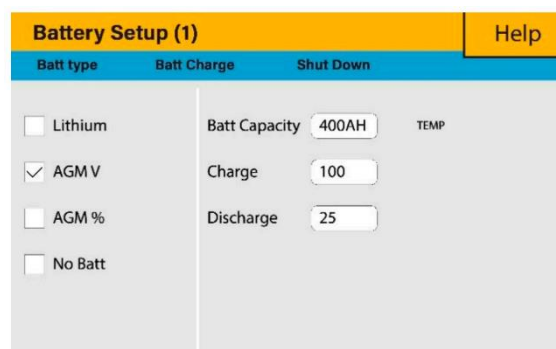
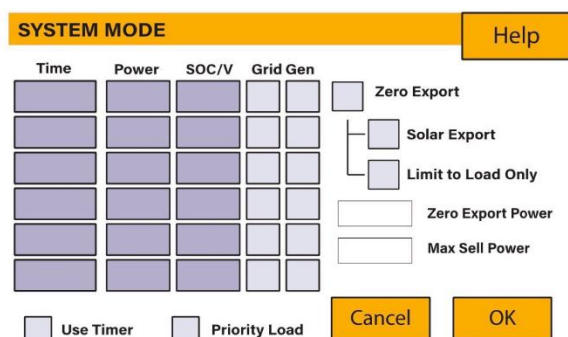
F47 AC over frequency / F48 AC lower frequency

Check the frequency settings on the inverter system on the grid page and adjust the frequency slightly up all down to match your grid.

F56 - DC busbar voltage is too low

Generally, this error is a battery problem, possibly a damaged BMS. If you experience an F56 fault, you need to focus on the battery, the battery cables, the battery connections, battery discharging parameters, and the general condition of the battery.

- 1) Check if battery cables are nice and tight.
- 2) If using a parallel configuration, check if all battery cables have the same length. As the batteries are low voltage compared to the mains, the current is high, so check the cable size and notice if they have the same length.
- 3) Check the C rating of the battery.
- 4) Check the maximum current discharge setting of the inverter.
- 5) Check the maximum power setting (Max sell Power) of the inverter.



F63 - ARC fault

This error is caused by a faulty connection on the solar panel, which causes noise.

This problem is actually a loose connection of the solar panels, and then something is causing noise on the solar cable. You can switch off, but it is better to locate the problem since there is a potential fire hazard.

For this type of fault, you really need to go and check every single solar panel, every single connection, since this fault can appear from nowhere. The system can normally be working, and then suddenly, in the middle of the day, this can happen.

F64 - Heat sink high-temperature failure

This error is displayed due to an over-temperature of the IGBT, possibly caused by a blocked fan or ventilation.

If this fault occurs and the problem is not solved rapidly, it can damage the inverter.

- 1) Switch off the inverter and allowed to cool down
- 2) Clean all ventilation
- 3) Ensure the fans are running correctly
- 4) Check if the inverter is installed in a very hot environment. If it is, then you will need to reduce the power of the load as this can happen frequently.

It is important that at least twice a year (for dusty environments this may need to be carried out more frequently) to clean all the cooling fans and air ducts.

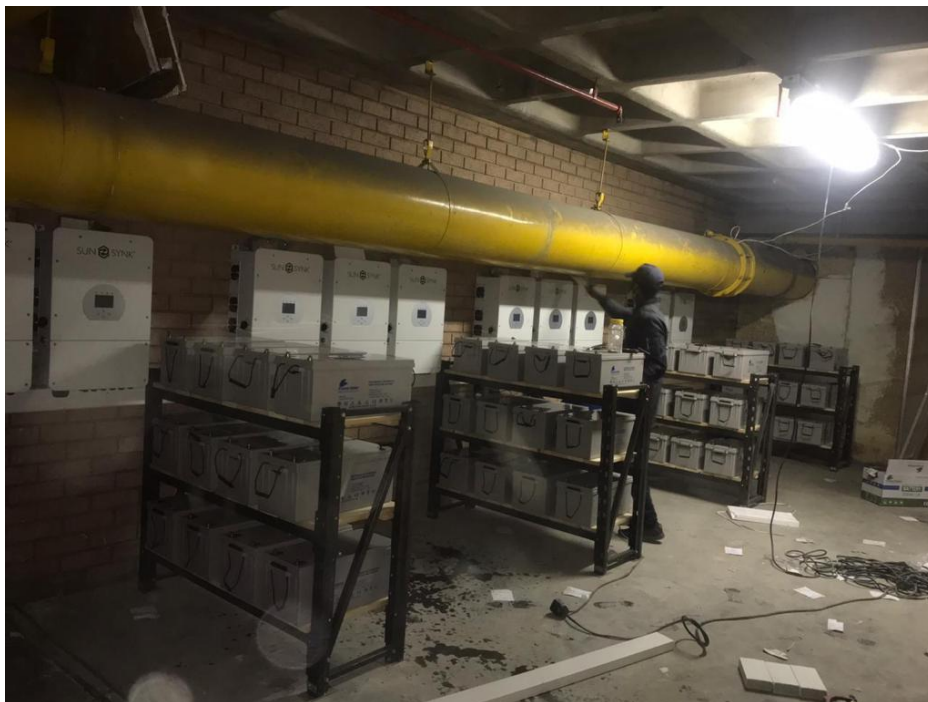


Figure 59 - Inverter installed in a dusty environment.



Global Tech China Ltd, 3 Floor, Wai Yip Industrial Building, 171 Wai Yip Street,
Kwun Tong, Kowloon, Hong Kong.

Tel: +852 2884 4318 Fax: +8522884 4816

www.sunsynk.com / sales@globaltech-china.com / www.globaltechhk.com